

Manual of Operation and Instruction

# Troxler RoadReader™

## Model 3440 Surface Moisture-Density Gauge



**Troxler Electronic Laboratories, Inc.**

3008 Cornwallis Rd. • P.O. Box 12057

Research Triangle Park, NC 27709

Phone: 1.877.TROXLER

Outside the USA: +1.919.549.8661

Fax: +1.919.549.0761

[www.troxlerlabs.com](http://www.troxlerlabs.com)



Troxler products are protected by U.S. and foreign Patents

Copyright © 2015-2020

Troxler Electronic Laboratories, Inc.

All Rights Reserved

No part of this manual may be reproduced or transmitted in any form or by any means, electronic or mechanical, including photocopying, recording, or information storage and retrieval systems, for any purpose without the express written permission of Troxler Electronic Laboratories, Inc.

*Magnalube-G* is a registered trademark of Magnalube, Inc.

*BindOff* is a registered trademark of Chemical Solutions, Inc.

PN 110991

October 2020

Edition 1.2

---

## SAFETY ALERT SYMBOL

---

The Safety Alert Symbol shall appear within this manual. Wherever it appears in this manual or on safety signs affixed to the machine, this is to make all aware of the potential for personal injury and to be cautious when these images are present.

Always observe all WARNING, CAUTION, and NOTE recommendations listed within this manual before operating the machine.

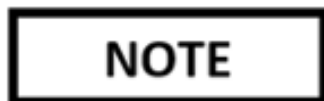

# TROXLER SERVICE CENTERS

## **Troxler Corporate Headquarters**

P.O. Box 12057

Research Triangle Park, NC 27709

Phone: 1.877.TROXLER (1.877.876.9537)

Outside the U.S.A.: +1.919.549.8661

Fax: +1.919.549.0761

## **Technical Support**

Phone: 1.877.TROXLER

(1.877.876.9537)

TroxTechSupport@troxlerlabs.com

## **North Carolina Service Center**

3008 E. Cornwallis Road

Research Triangle Park, NC 27709

Phone: +1.919.549.8661

Fax: +1.919.549.0761

TroxTechSupport@troxlerlabs.com

## **Florida Office & Service Center**

2376 Forsyth Road

Orlando, FL 32807

Phone: +1.407.681.4221

Fax: +1.407.681.3188

TroxTechSupport@troxlerlabs.com

## **Midwestern Office & Service Center**

1430 Brook Drive

Downers Grove, IL 60515

Phone: +1.630.261.9304

Fax: +1.630.261.9341

TroxTechSupport@troxlerlabs.com

## **Western Office & Service Center**

11300 Sanders Drive, Suite 7

Rancho Cordova, CA 95742

Phone: +1.916.631.0234

Fax: +1.916.631.0541

TroxTechSupport@troxlerlabs.com

## **Southwestern Office & Service Center**

2016 East Randol Mill Rd., Suite 406

Arlington, TX 76011

Phone: +1.817.275.0571

Fax: +1.817.275.8562

TroxTechSupport@troxlerlabs.com

## **Troxler Europe & Service Center**

Troxler Electronics GmbH

Waldstrasse 4, D.82239 Alling nr.

Munich, Germany

Phone: ++ 49.8141.71063

Fax: ++49.8141.80731

troxler@t-online.de

## **Troxler Electronic Technologies (Zhangjiagang)**

1F, Bldg G, No. 1 Guotai North Road  
ZJG, China, 215600

Phone: 0086.512.56793702

Fax: 0086.512.56793701

kjin@troxlerlabs.cn

To locate an independent, Troxler-authorized service partner near you, call 1.877.TROXLER (1.877.876.9537).

# ABOUT THIS MANUAL

The Model 3440 *Manual of Operation and Instruction* provides detailed information about this gauge. The manual includes product safety information, as well as instructions for the proper installation and use of the Model 3440 gauge.

This manual is organized as follows:

**Chapter 1, Introduction** – Provides information on the safe use of the gauge; a brief overview of the unit and its features; a list of parts and accessories; and instructions for unpacking and inspection.

**Chapter 2, Theory of Operation** – Provides a brief description of how the gauge's operations work in relation to their sources.

**Chapter 3, Gauge Setup** – Describes the keypad and provides instructions for setting up, starting, and operating the gauge.

**Chapter 4, Using the Gauge** – Describes taking a standard count, preparing the test site, and taking measurements.

**Chapter 5, Setup Menu** – Describes the options available from the Setup menu.

**Chapter 6, Target Menu** – Describes the options available from the Target menu.

**Chapter 7, Calibration Offsets** – Provides procedures for taking density, moisture, and trench offsets.

**Chapter 8, Project Data** – Describes the options available from the Project menu.

**Chapter 9, Extended Menu** – Describes the options available from the Extended menu.

**Appendix A, Maintenance & Troubleshooting** – Provides maintenance and service information, as well as instructions for basic troubleshooting.

**Appendix B, Specifications** – Contains mechanical, electrical, and environmental performance specifications.

**Appendix C, Transporting and Shipping** – Provides information about shipping requirements for the United States and Canada.

**Appendix D, Radiation Safety & Theory** – Provides a radiation primer, regulatory requirements, and gauge safety precautions.

**Appendix E, Unit Conversion** – Provides conversions for measurement and radiological units.

**Appendix F, Standard Count Log** – Use this form to record your standard count readings.

**Appendix G, Special European Considerations** – Provides the Declaration of Conformity and special safety warnings.

**Appendix H, Global Positioning System (GPS)** – Describes the accuracy of the optional GPS feature.

## HOW TO USE THIS MANUAL

Congratulations on the purchase of the Troxler Model 3440 Surface Moisture-Density Gauge.

The Model 3440 *Manual of Operation and Instruction* contains information on how the Model 3440 operates, and provides directions on the use of this gauge. Site selection, basic parameter setup, moisture and density determination, data storage, and advanced operations are included, along with radiological information and system troubleshooting.



# CONVENTIONS USED IN THIS MANUAL

Throughout this manual the following symbols and special formatting are used to reveal the purpose of the text.



## WARNING!

Warnings indicate conditions or procedures that, if not followed correctly, may cause personal injury.

## CAUTION

Cautions indicate conditions or procedures that, if not followed correctly, may cause equipment damage.

## NOTE

Notes indicate important information that must be read to ensure proper operation.

⟨**KEY**⟩ This style indicates a key or character to press on the ADU keypad.

**DISPLAY–Typestyle and shading used to simulate the control panel display**

1. Indicates a procedure with multiple steps.
- ◆ Indicates a list of things needed (such as equipment) or important points to know.
- ▶ Indicates that more than one option is available. Carefully select the option that applies.

## CAUTIONS AND WARNINGS



When not taking measurements, always keep the source rod in the SAFE position. For added operator safety, the source rod on the gauge automatically retracts to the SAFE position when the gauge is picked up by the handle.



Do not store or transport the gauge unless the sliding block is completely closed. Increased radiation levels may violate transportation regulations and cause excessive personnel exposure.



Units intended for use in countries that are members of the European Community are shipped with an AC adapter, Troxler part number 108354.



Gauge cover is to be removed by trained service personnel only. There are no user-serviceable components inside. Note that components behind the cover can have voltage potentials in excess of 50 volts during normal operation of the gauge.



Appendix D, Radiation Theory and Safety should be read carefully and understood before using the gauge.



The Model 3440 gauges are not waterproof. Please do not use them in the rain. If the gauge gets wet, make sure it is completely dry before sealing it in the case for storage. Even small amounts of moisture can get into the body of the gauge and cause damage. If you suspect that moisture may be inside the gauge open the keypad panel and run a fan or hairdryer (on low) in the gauge for an hour or more until dry. See page Troubleshooting on page A-2 for more information.

# TABLE OF CONTENTS

<b>CHAPTER 1: INTRODUCTION .....</b>	<b>1-1</b>
Introduction .....	1-2
Gauge Parts and Accessories .....	1-5
Unpacking and Inspection .....	1-7
<b>CHAPTER 2: THEORY OF OPERATION.....</b>	<b>2-1</b>
Density.....	2-2
Moisture.....	2-5
Calibration.....	2-7
<b>CHAPTER 3: GAUGE SETUP .....</b>	<b>3-1</b>
Gauge Illustration.....	3-2
Control Panel.....	3-3
Source Rod Positions .....	3-5
Daily Inspection .....	3-6
Turning the Gauge On .....	3-6
Gauge Setup.....	3-8
<b>CHAPTER 4: USING THE GAUGE .....</b>	<b>4-15</b>
Taking the Standard Count.....	4-16
Site Preparation .....	4-22
Taking Measurements.....	4-25
Recall .....	4-31
<b>CHAPTER 5: SETUP MENU .....</b>	<b>5-1</b>
Setup Menu .....	5-2
Stat Test.....	5-3

Drift Test .....	5-6
Nomograph.....	5-9
Precision .....	5-14
Options .....	5-16
Percent Air Voids (Soil Mode) .....	5-18
<b>CHAPTER 6: TARGET MENU.....</b>	<b>6-1</b>
Target Menu.....	6-2
Target Values .....	6-3
<b>CHAPTER 7: CALIBRATION OFFSETS.....</b>	<b>7-1</b>
About Offsets .....	7-2
Density Offset.....	7-4
Moisture Offset.....	7-5
Trench Offset.....	7-9
<b>CHAPTER 8: PROJECT DATA .....</b>	<b>8-1</b>
Project Menu.....	8-2
Select a Project .....	8-3
View Project Data.....	8-4
Create a Project.....	8-5
Erase Projects.....	8-6
Output Project .....	8-7
Set Output Destination.....	8-11
Deactivate a Project.....	8-11
Auto-Store .....	8-12
Manual Store .....	8-14
<b>CHAPTER 9: EXTENDED MENU .....</b>	<b>9-1</b>

Extended Menu .....	9-2
Clock/Calendar .....	9-3
User ID.....	9-3
Customer Name .....	9-3
Language.....	9-4
Source Decay .....	9-4
Erase Standard Counts.....	9-5
Low Battery Warning.....	9-6
Software Reset .....	9-7
Test Menu .....	9-7

**APPENDIX A : MAINTENANCE & TROUBLESHOOTING.. A-1**

Troubleshooting .....	A-2
Display Contrast .....	A-10
Batteries .....	A-11
Battery Charging .....	A-13
Mechanical Maintenance .....	A-16
Replacement Parts.....	A-20
Returning the Gauge for Service .....	A-22

**APPENDIX B : SPECIFICATIONS..... B-1**

Measurement Specifications .....	B-2
Radiological Specifications .....	B-4
Electrical Specifications.....	B-4
Mechanical Specifications.....	B-6

**APPENDIX C : TRANSPORTING & SHIPPING ..... C-1**

U.S. Shipping Requirements.....	C-2
---------------------------------	-----

Canadian Shipping Requirements.....	C-4
<b>APPENDIX D : RADIATION THEORY &amp; SAFETY .....</b>	<b>D-1</b>
Radiation Theory .....	D-2
Radiation Safety.....	D-5
Regulatory Requirements .....	D-13
Gauge Use Precautions .....	D-16
Radiation Profile .....	D-17
<b>APPENDIX E : UNIT CONVERSION .....</b>	<b>E-1</b>
Measurement Units .....	E-2
Radiological Units.....	E-2
<b>APPENDIX F : STANDARD COUNT LOG .....</b>	<b>F-1</b>
<b>APPENDIX G : SPECIAL EUROPEAN CONSIDERATIONS .</b>	<b>G-1</b>
Declaration of Conformity .....	G-2
Safety Warnings.....	G-3
<b>APPENDIX H : GLOBAL POSITIONING SYSTEM (GPS).....</b>	<b>H-1</b>
GPS Accuracy .....	H-2

## **INDEX**

## **WARRANTY**

## LIST OF FIGURES

Figure 1. Model 3440 Gauge and Accessories.....	1-6
Figure 2. Direct Transmission Geometry .....	2-3
Figure 3. Backscatter Geometry .....	2-3
Figure 4. Backscatter Surface Density Effects.....	2-4
Figure 5. Effect of Moisture on Depth of Measurement.....	2-6
Figure 6. Gauge Illustration .....	3-2
Figure 7. Model 3440 Keypad .....	3-3
Figure 8. Source Rod Positions .....	3-5
Figure 9. Standard Count Position .....	4-18
Figure 10. Drill Rod Positioning .....	4-23
Figure 11. Marking the Test Area.....	4-24
Figure 12. Adjusting the Display Contrast .....	A-10
Figure 13. NiMH Battery Pack and AA Batteries.....	A-12
Figure 14. Diagram of an Atom.....	D-2
Figure 15. Effect of Distance on Exposure.....	D-6
Figure 16. Cleaning the Tungsten Sliding Block.....	D-11
Figure 17. Model 3440 Gauge and Transport Case.....	D-17

## LIST OF TABLES

Table 1. Model 3440 Keypad Functions.....	3-4
Table 2. Spreadsheet Column Definitions.....	8-10
Table 3. Error Messages.....	A-7
Table 4. Typical Battery Operating Life.....	A-12
Table 5. Radiation Profile for Model 3440 Gauge .....	D-18
Table 6. GPS Position Accuracy .....	H-4



## **ATTENTION MODEL 3440 GAUGE OWNER**

This unit contains functions that require an Access Code to be entered. This allows some control over the access to these functions. If you would like management to retain this control, remove this page upon receipt of the gauge and file it somewhere safe.

**THE ACCESS CODE IS FOR THIS GAUGE IS:**

**4708**



# Chapter 1:

# Introduction

---

This chapter covers the following topics and tasks:

- ✓ An introduction to your new Model 3440 gauge
- ✓ Inspecting and unpacking
- ✓ Included parts and accessories

# Introduction

---

The Model 3440 Surface Moisture-Density Gauges have become the industry standard for measuring the moisture content and density of construction materials. With the new Model 3440 gauge, Troxler has added a number of features to the proven technology of the company's earlier products to provide increased performance, flexibility, ease of use, and operator safety.

Using the Model 3440 gauge, you can quickly and precisely measure the moisture content and density of construction materials. The gauge features:

- ◆ Two measurement modes (Soil and Asphalt) for precise compaction control readings in most construction materials:
  - Use **Soil Mode** for moisture/density determinations in soil and soil-stone materials in layers of four inches or greater.
  - Use **Asphalt Mode** for density determinations in asphalt or hardened concrete layers of four inches or greater.
- ◆ A **Nomograph** function for density determinations in asphalt layers of fewer than four inches.
- ◆ **Calibration offsets** (density, moisture, and trench) to expand measurement possibilities, and to enhance gauge readings on materials that may fall outside the range of factory calibration.
- ◆ Over **30 functions** to facilitate all phases of testing compaction on construction materials.
- ◆ A **backlit LCD screen** to help you read the display during night construction.
- ◆ Easy-to-use **keypad** and user-friendly menus to reduce training time to increase productivity. A backlit keypad is available as an upgrade (see page 5–17 for more information).
- ◆ An internally mounted **beeper**, which emits a short tone in response to a valid keystroke on the keypad. The beeper sounds a longer tone if you press an invalid key, if the gauge

displays an error message, or to signal the conclusion of a measurement.

- ◆ A **USB port** that can be used to output data to a USB printer or flash drive. A list of compatible USB devices is available at: [www.troxlerlabs.com/documents](http://www.troxlerlabs.com/documents)
- ◆ A **serial port** used to connect the gauge to a computer or printer for data transfer and printing.
- ◆ An optional **remote keypad**, including a **⟨START⟩** and **⟨ESC⟩** key, at the top of its source rod housing. See page 5–16 for more information.
- ◆ In addition to the internal beeper, a louder **external beeper** is available (see page 5–16). The external beeper performs the same functions as the internal one, and can be enabled or disabled as required.

The Model 3440 can also be equipped with an optional *global positioning system (GPS) receiver*. The GPS receiver enables the gauge to store precise GPS coordinates, along with the standard date and time stamp, for each measurement. For more information on the GPS option, refer to page 5–17.

## ASTM Standards

The Model 3440 gauges meet or exceed all applicable American Society of Testing and Materials (ASTM) standards (or corresponding equivalent), including:

- ◆ ASTM D-2950: Standard Test Method for Density of Bituminous Concrete in Place by Nuclear Method.
- ◆ ASTM D-6938: Standard Test Methods for In-Place Density and Water Content of Soil and Soil-Aggregate by Nuclear Methods (Shallow Depth)

## NOTE

As of November 2006, ASTM D-6938 replaces ASTM D-2922: Standard Test Methods for Density of Soil and Soil-Aggregate in Place by Nuclear Methods (Shallow Depth) and ASTM D-3017: Standard Test Method for Water Content of Soil and Rock in Place by Nuclear Methods (Shallow Depth).

Any licensing issues discussed in this manual are for the United States. To purchase a Model 3440 in Canada, owners must obtain a radioisotope license from the Canadian Nuclear Safety Commission (CNSC). The owner should obtain copies of the CNSC Regulations and the *Transportation of Dangerous Goods Act and Regulations* (TDG). For other countries, please consult your local regulatory agency.

Owners are encouraged to require study of this manual before allowing anyone to use the gauge. ***A potential hazard does exist if improperly used.*** Appendix C and Appendix D, which cover radiological safety and transportation requirements, should be required reading for all users and potential users. **If these appendices are not completely understood, users should seek assistance from Troxler, an appointed Troxler representative, or others designated within the user's organization.**

Additional radiation safety information is available by completing a Troxler Nuclear Gauge Safety Training Course. For pricing and availability of these in-person and online courses, visit the Troxler website at [www.troxlerlabs.com/training](http://www.troxlerlabs.com/training) or contact your Troxler representative.

Before operating the gauge, users in European countries must refer to : *Special European Considerations* for special considerations, additional safety warnings, and the Declaration of Conformity.

Because changes are made to local, state, and federal regulations on a continuing basis, the owner/operator must maintain awareness of current requirements. *The responsibility for compliance ultimately falls on the owner.* An owner in the United States may also wish to purchase and subscribe to Titles

10 and 49 of the *Code of Federal Regulations* (CFR) in addition to applicable local/state regulations.

## Gauge Parts and Accessories

---

Use Figure 1 and the list below to identify the gauge and parts as they are unpacked.

- ◆ The **gauge** is the portable instrument containing all electronic modules, the rechargeable battery pack, detectors, and the radioactive sources.
- ◆ The **Reference Standard Block** provides a measurement standard for standard counts and is used during stat and drift tests.
- ◆ The **Drill Rod** is used to drill holes for direct transmission measurements. ***Do not use the source rod of the gauge to drill holes.***
- ◆ The **Scraper Plate / Drill Rod Guide** is used to prepare the test site and to guide the drill rod when preparing the site for direct transmission measurements.
- ◆ The **Extraction Tool** provides leverage to remove the drill rod from soil materials.
- ◆ The **AC charger** and **DC adapter** are used to charge the gauge batteries. The AC charger accepts 90 – 220 V AC, 50/60 Hz and supplies 12 V DC. The DC adapter allows recharging from an automobile accessory power outlet.
- ◆ The **Transport Case** provided with the gauge has been approved as a Type A package and should not be altered. Always use this transport case when transporting or shipping the gauge.
- ◆ The ***Manual of Operation and Instruction*** details how to use the gauge.

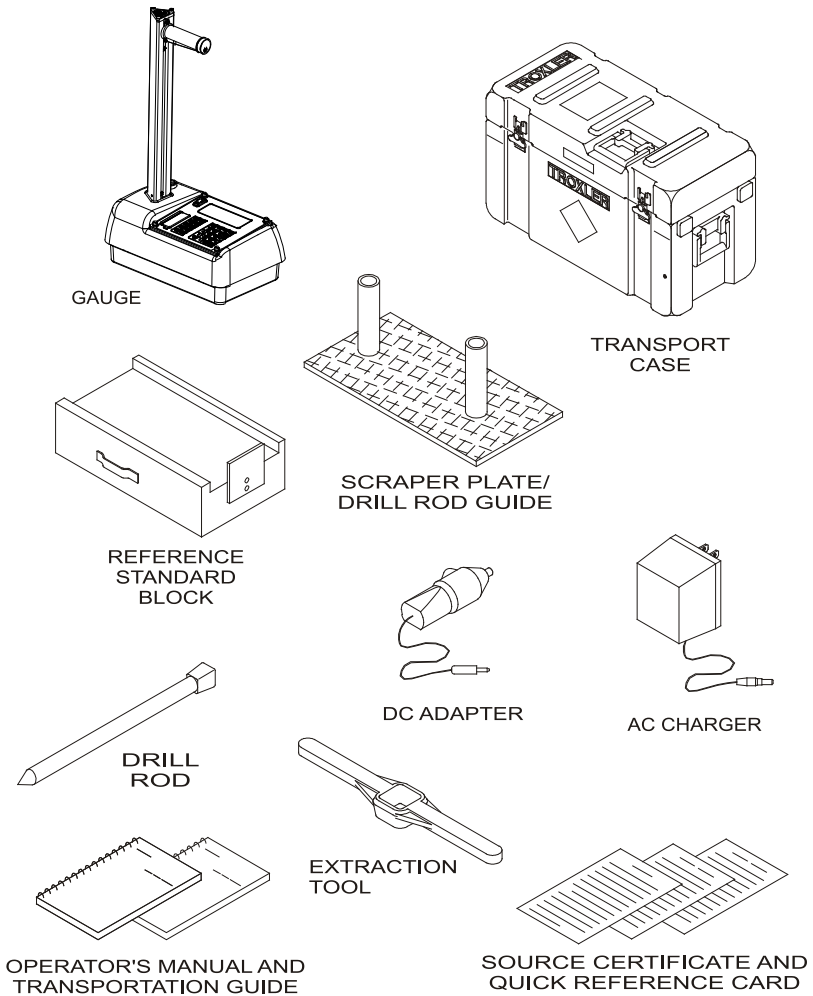

Figure 1. Model 3440 Gauge and Accessories



# Unpacking and Inspection

---

Troxler recommends that all operators wear a dosimeter while working with the gauge. Upon receipt of the gauge from the factory, perform a complete inspection and inventory. If the shipping case and/or any other part or accessory appears damaged, notify the carrier and your Troxler Representative immediately.

Save the box and any packing material for shipping to another location or back to the factory

Check the shipping case for the following:

- ◆ Gauge
- ◆ Reference Standard Block
- ◆ Drill Rod
- ◆ Scraper Plate/Drill Rod Guide
- ◆ Extraction Tool
- ◆ AC charger
- ◆ DC adapter (for a vehicle cigarette lighter)
- ◆ *Manual of Operation and Instruction*
- ◆ Gauge warranty
- ◆ Source Certificate
- ◆ *Transportation Guide* (This guide refers to U.S. standards. All other countries please refer to local regulations. In the absence of local regulations, please use this guide as a reference only.)

## NOTE

**Charge the batteries for three hours prior to initial use.**

Complete the unpacking and inspection by following these steps:

1. Lift the gauge from the transport case and inspect the outside surface for damage.
2. Check the lock on the source rod handle and make sure the keys fit.
3. Remove the lock, release the trigger, and check the source rod operation. It should move up and down with minimal effort.
4. Replace the handle lock and return the gauge to the transport case.

## NOTES

# Chapter 2:

# Theory of Operation

---

This chapter covers the following topics and tasks:

- ✓ Theory of operation
- ✓ Direct transmission and backscatter modes
- ✓ Overview of density and moisture measurements
- ✓ Explanation of the sources and detector geometry

# Density

---

The Model 3440 gauge utilizes two modes of operation: *direct transmission mode* (with the source rod extended into the material) and *backscatter mode*. Figure 2 and Figure 3 illustrate these two modes of operation.



## WARNING!

The source rod should always be locked in the SAFE position when the gauge is not in use.

Source rod positions are described on page 3–5.

In *direct transmission* mode, the rod containing the Cesium-137 (8 mCi/0.3 GBq) source is lowered to the desired depth. The detectors in the gauge base measure the radiation emitted by the source rod. Gamma photons reaching the detectors must first pass through the material, colliding with electrons present in the material. Generally, the lower the number of photons that reach the detectors, the more dense the material is.

In *backscatter* mode, the gamma photons that enter the material must be scattered (or reflected) to reach the detectors. With the rod locked in the first notch, the source and detectors are in the same plane, referred to as the backscatter position. Photons emitted from the source penetrate the material and the detectors measure the scattered photons.

While the direct transmission geometry measures the average density of the material from the source to the surface, the backscatter geometry yields an average heavily weighted by the density close to the surface.

Figure 4 shows two normalized *top layer effect curves*, illustrating the percentages of photons at the detectors for various depths. The two curves can be used to compute the gauge response to layered material of different densities. For example, the density of the top inch of a surface layer accounts for about 52% of the backscatter density measurement.

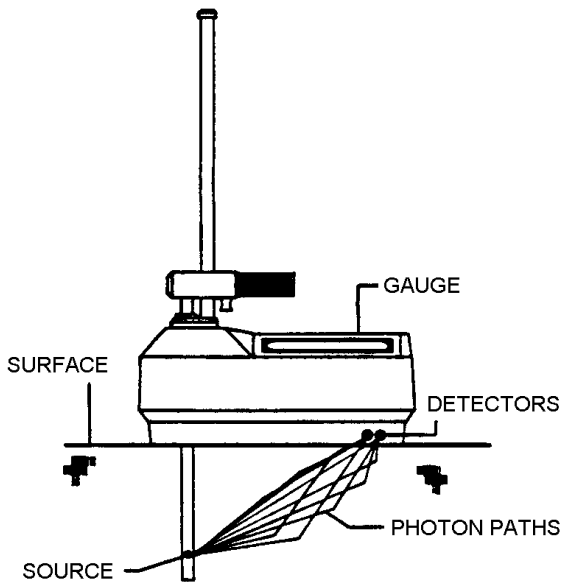

Figure 2. Direct Transmission Geometry

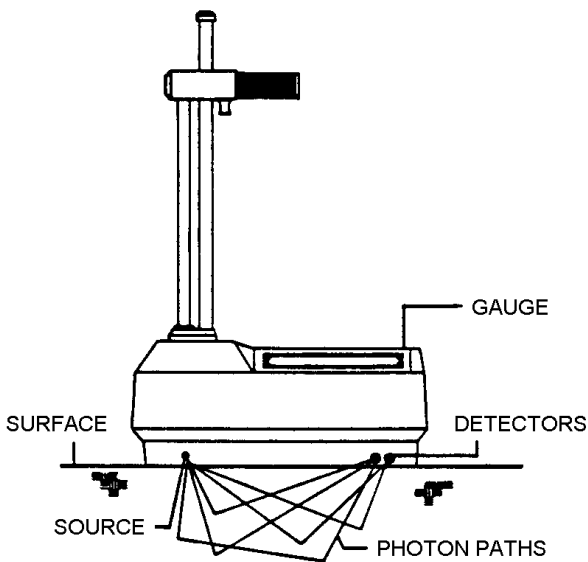
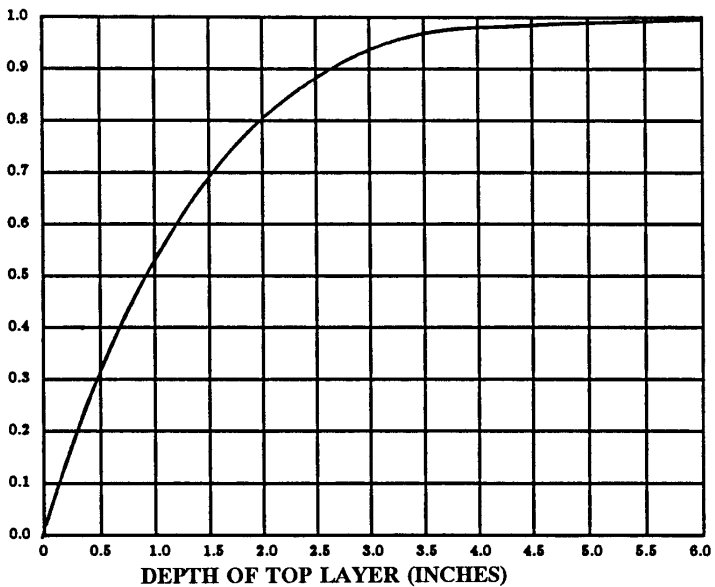

Figure 3. Backscatter Geometry

T  
O  
P  
L  
A  
Y  
E  
R  
E  
F  
F  
E  
C  
T



T  
O  
P  
L  
A  
Y  
E  
R  
E  
F  
F  
E  
C  
T

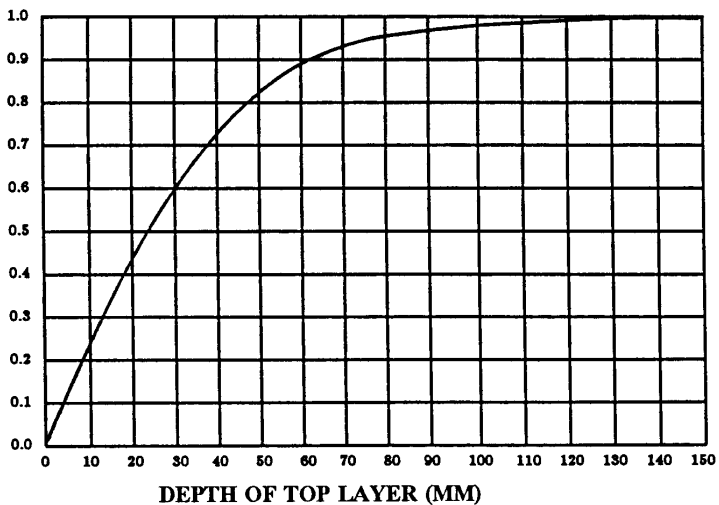

Figure 4. Backscatter Surface Density Effects  
(Top Layer Effect Curves)

# Moisture

---

The Model 3440 gauge uses a 40 mCi (1.48 GBq) Americium-241:Beryllium neutron source to measure the hydrogen content (consequently the water content) of the material.

Neutrons emitted by the Am-241:Be source penetrate the material and are *thermalized* (or slowed). *Thermalization* is the process where neutrons are slowed to the point where further collisions with hydrogen or other materials will not continue to slow the neutron.

The Model 3440 gauge contains a helium-3 neutron detector that is sensitive to thermalized neutrons. This detector is insensitive to non-thermalized or “fast” neutrons and, as a result, the counts obtained are directly proportional to the amount of hydrogen/moisture present in the material.

The *depth of measurement*, or depth at which 98% of the counted neutrons pass before reaching the detector, is a function of moisture content:

$$\text{Depth (in.)} = 11 - (0.17 \times M), \text{ where: } M = \text{moisture in pcf}$$

or

$$\text{Depth (mm)} = 280 - (0.27 \times M), \text{ where: } M = \text{moisture in kg/m}^3$$

Therefore, the higher the moisture content in the material being measured, the smaller the depth of measurement. The normalized curve set shown in Figure 5 illustrates the effect of moisture content on the depth of measurement.

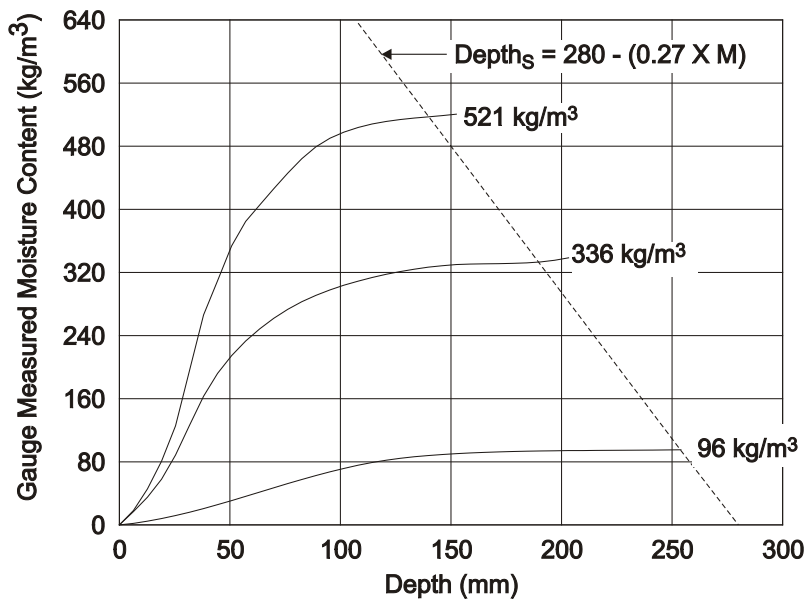
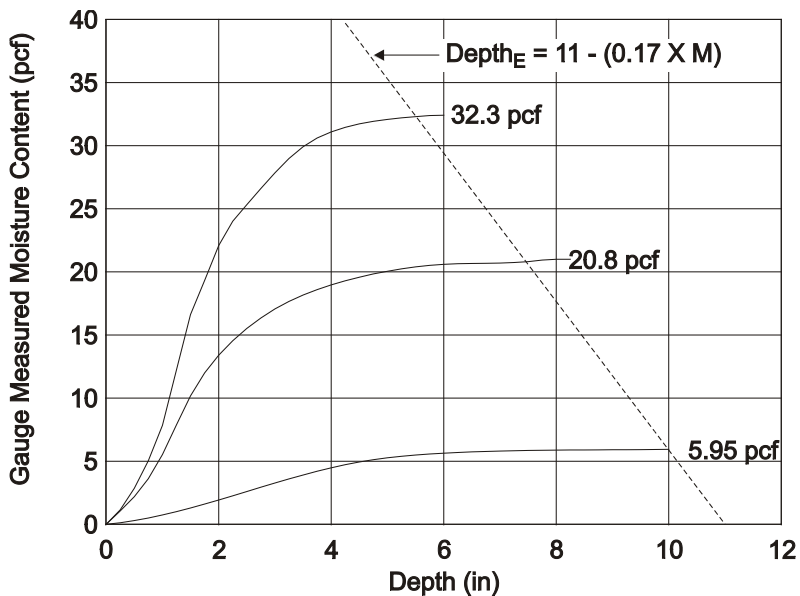

Figure 5. Effect of Moisture on Depth of Measurement



# Calibration

---

Troxler calibrates the gauge at the factory and recommends that it always be calibrated by an authorized Troxler service center. For a list of Troxler and authorized Troxler service centers, refer to page *iii* of this manual or visit the Troxler website at: [www.troxlerlabs.com/services](http://www.troxlerlabs.com/services)

## Offsets

The factory calibration provides accurate results for the majority of materials encountered in construction. If the gauge is to be used to test materials not covered by the factory calibration, the readings can be adjusted using an *offset*.

Perform a *density offset* if the test material is outside the density range for average soil or if the material composition varies from average soil/asphalt.

Perform a *moisture offset* if the test material contains hydrogenous materials (other than water) or materials that absorb neutrons. Materials such as cement, gypsum, coal, mica, and lime all contain chemically bound hydrogen that will cause the gauge to display a moisture content that is higher than it actual. Material such as boron and cadmium are neutron absorbers and will cause the gauge to display a moisture count that is lower than actual.

Vertical structures scatter neutrons and gamma photons back to the gauge. This could result in inaccurate moisture and density readings. To take readings in a trench or within 0.6 m (2 ft.) of a large vertical structure, perform a *trench offset*.

# NOTES

# Chapter 3:

# Gauge Setup

---

This chapter covers the following topics and tasks:

- ✓ Overview of the control panel
- ✓ Source rod positions
- ✓ Daily inspection
- ✓ Turning the gauge on
- ✓ Using the Setup menu

# Gauge Illustration

---

The following figure shows the various components of the gauge that will be referred to throughout this manual.

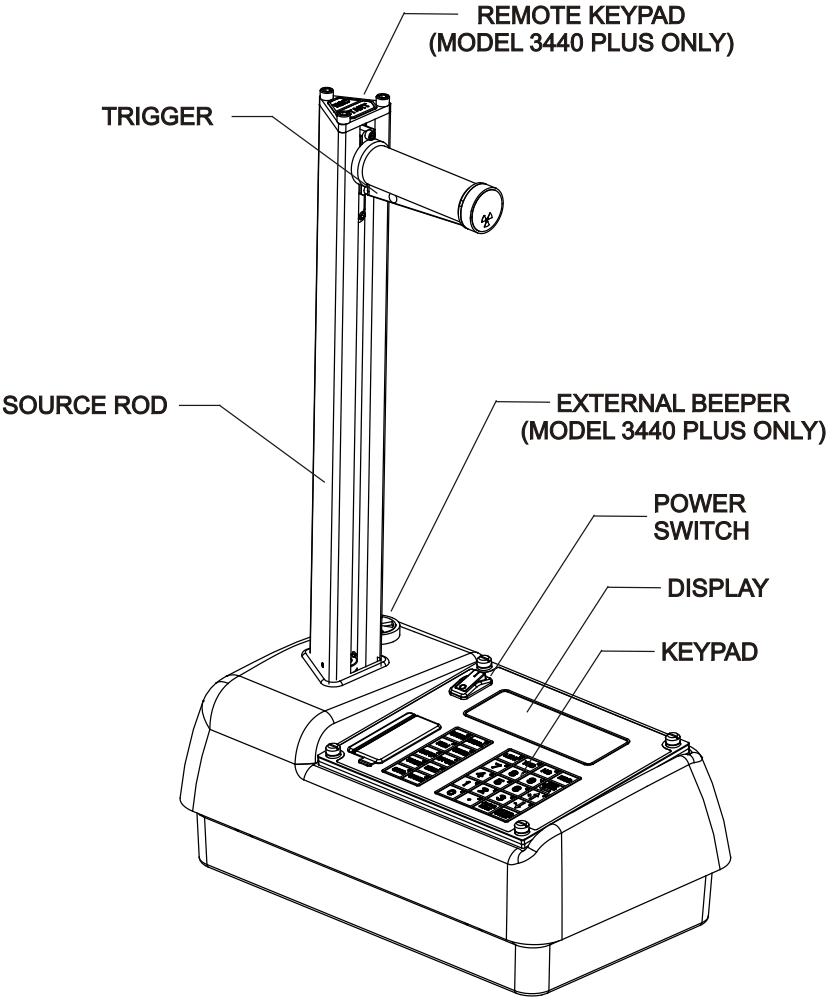

Figure 6. Gauge Illustration

# Control Panel

The gauge's control panel contains the keypad, power switch, display, and USB port, battery charging indicator, charger connector, and the RS-232 port.

The gauge is equipped with an internal beeper to verify keystrokes. If a beep is not heard when a key is pressed, the keystroke was not recognized and should be repeated.

Table 1 on page 3-4 provides a description of each key.

## NOTE

The gauge will automatically turn off after five hours if no keys are pressed.

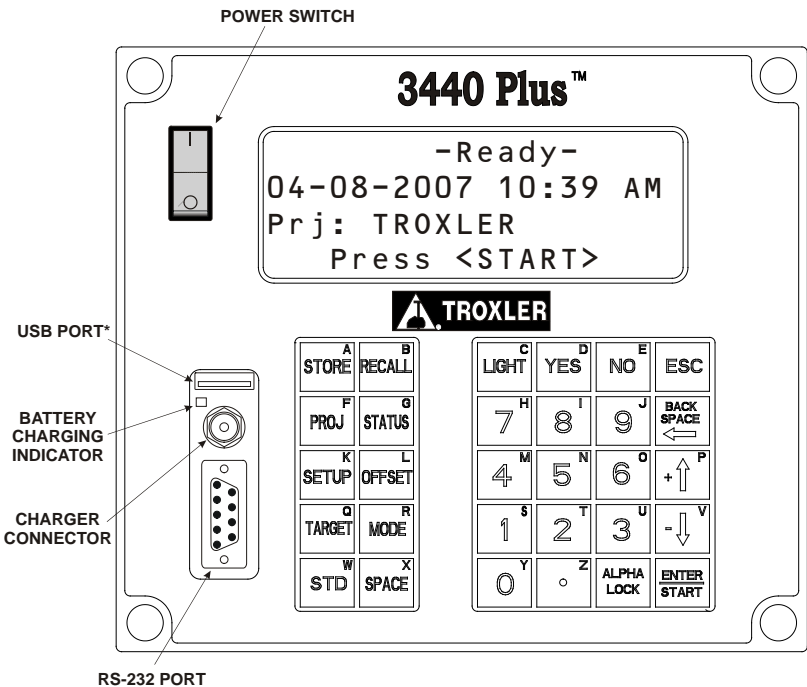

Figure 7. Model 3440 Keypad

Table 1. Model 3440 Keypad Functions

KEY	FUNCTION
⟨STORE⟩	Store the most recent data in the current project file.
⟨RECALL⟩	Display the most recent data.
⟨PROJ⟩	Select or create a project file and view, output, or erase project data file.
⟨STATUS⟩	Display gauge status information.
⟨SETUP⟩	Display the gauge Setup menu.
⟨OFFSET⟩	Enable, disable, or change a density, moisture, or trench offset.
⟨TARGET⟩	Select, enter, or disable a Gmb (Marshall), Proctor, or Gmm (Voidless density) value.
⟨MODE⟩	Select Asphalt or Soil measurement mode.
⟨STD⟩	Take a standard count.
⟨SPACE⟩	Enter a space.
⟨LIGHT⟩	Manually toggle the LCD and keypad backlights on and off.
⟨YES⟩	Respond yes to yes/no questions.
⟨NO⟩	Respond no to yes/no questions.
⟨ESC⟩	Return the display to the Ready screen without storing or updating the data.
⟨0⟩ .. ⟨9⟩	Enter numbers and access menu options.
⟨BACK SPACE⟩	Moves cursor back one space.
⟨↑⟩, ⟨↓⟩	Scroll through menu options or view screens.
⟨.⟩	Enter a decimal point.
⟨ALPHA LOCK⟩	Access the letters.
⟨A⟩ .. ⟨Z⟩	Enter letters. Access these keys by first pressing ⟨ALPHA LOCK⟩.
⟨ENTER/START⟩	Accept data entry or begin a measurement.

# Source Rod Positions

As shown in Figure 8, the source rod can be placed in the **SAFE**, backscatter, or direct transmission positions. When not taking measurements, keep the source rod in the **SAFE** position.

When measuring thin layer or other materials through which you cannot drill a hole, use the backscatter position. In the direct transmission positions, the source rod extends into a pre-drilled hole.

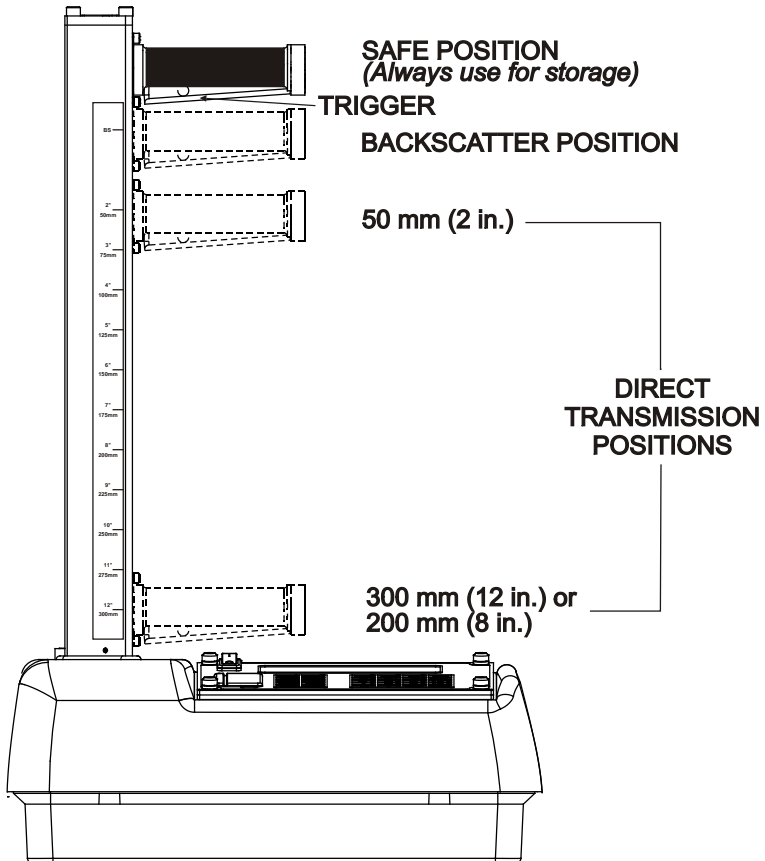

Figure 8. Source Rod Positions

(Maximum Depth of 300 mm in Increments of 50 mm)

# Daily Inspection

---

The gauge should be inspected daily before use to ensure proper operation of all safety features. Refer to page D-9 for the inspection procedure.

## Turning the Gauge On

---

The gauge uses rechargeable NiMH batteries (included) as a power source. When first turned on, the control panel displays test characters before proceeding to the self-test.

To turn the gauge on, toggle the on/off switch located to the left of the gauge's display. Upon turning the gauge on, the gauge displays:

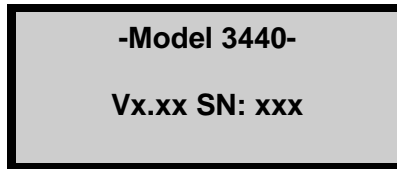

**-Model 3440-**  
**Vx.xx SN: xxx**

The gauge then performs a test of its LCD (liquid crystal display):

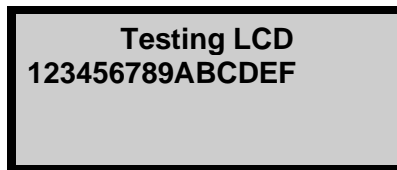

**Testing LCD**  
**123456789ABCDEF**

After the gauge performs a 300-second self-test, the gauge enters the *Ready* mode. In this state any of the gauge functions may be accessed.

The *Ready* mode display is:

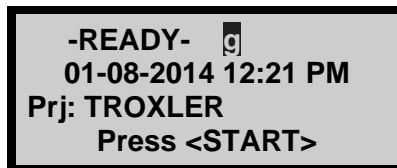

**-READY-**   
**01-08-2014 12:21 PM**  
**Prj: TROXLER**  
**Press <START>**



## NOTE

The symbol  in the upper right of the display indicates that the GPS option (see page 5-17) is installed, the option is enabled, and the gauge is receiving GPS satellite signals.

## NOTE

If the gauge display is difficult to read in bright light, adjust the contrast as described in the Display Contrast section on page A-10.

After five hours of no activity, the gauge automatically performs a total power shutdown.

## NOTE

If the charge calibration (see page A-14) is BAD, the gauge will not perform an automatic shutdown.

# Gauge Setup

---

After turning the gauge on, you can set several parameters, including measurement units and count time. These parameters do not usually change once they are set.

The gauge offers a *Status* function that enables you to view selected information about the current gauge status and setup. To access this function, press the **<STATUS>** key.

The gauge displays two screens of information, including the measurement units, count time, measurement mode, battery status, Gmb (Marshall) value, Proctor value, Gmm (Voidless density) value, and measurement depth. Use the arrow keys to scroll between the two screens.

To begin, press the **<SETUP>** key. For information on all of the functions available from the *Setup* menu, see Chapter 5: Setup Menu.

## Setting the Count Time

The *count time* defines how long the gauge measures. Longer count times produce better measurement precision. Troxler recommends a count time of one minute for most sample measurements.

To change the count time, press **<1>** at the *Setup* menu. The gauge displays:



The first line displays the current count time. Select the desired count time using the corresponding number key. The gauge sets the new count time and returns to the *Setup* menu.

## Setting Measurement Units

The gauge can display measurement results in either U.S. units (pcf) or metric (SI) units ( $\text{kg}/\text{m}^3$  or  $\text{g}/\text{cm}^3$ ). To select the units, press **<2>** at the *Setup* menu. The gauge displays:

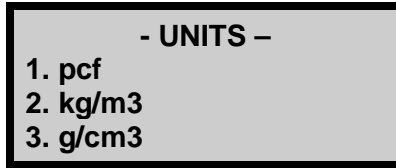

Select the new units using the corresponding number key. The gauge sets the new units and returns to the *Setup* menu.

## Setting the Depth

The Model 3440 gauge offers two depth modes: *Automatic* and *Manual*. In the *Automatic* mode, the gauge software determines the source rod depth automatically. In the *Manual* mode, the operator must enter the source rod depth at a gauge prompt whenever taking a measurement.

The *Depth Mode* function allows you to set the depth mode. To access this function, press **<2>** at the *Setup* menu. The gauge displays:

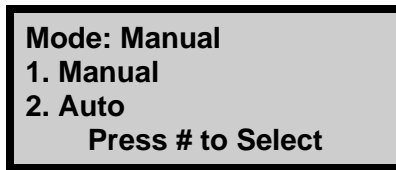

Select the desired depth mode using the corresponding number key. After the depth mode is selected, the gauge sets the mode and returns to the *Setup* menu.

# Extended Menu

The gauge is shipped with the current date and time (Eastern Standard Time) stored in its memory. In addition, the gauge can store a *user ID* and *customer name*. These settings are accessed from the *Extended* menu.

This menu includes functions that are intended for use by authorized personnel only, and requires the use of the *access code* shown at the front of this book.

To access the *Extended* menu, press <.> <9> at the *Setup* menu. The gauge requests an access code:



After entering the access code (see page xv), the gauge displays the *Extended* menu.

After setting the date and time, user ID, and/or customer name as described in the following sections, press <ESC> to return to the *Setup* menu.

For information on all of the functions available from the *Extended* menu, refer to *Chapter 9: Extended Menu*.

## Clock/Calendar

The *Clock/Calendar* function allows the operator to change the date and time, and to select the display format for each. To access the *Clock/Calendar* menu, press <1> at the *Extended* menu.

The gauge displays:



- Clock/Calendar ↑  
4. Date Format

Use the up and down arrows to scroll between the menu options. To select a menu option, press the corresponding numeric key. To return to the *Extended* menu, press the **<ESC>** key.

### CHANGE TIME

To change the time, press **<1>** at the *Clock/Calendar* menu. The gauge displays:

hh: mm AM  
Arrow toggle AM/PM  
Input Time and  
Press **<ENTER>**

(Note that in this example, the time is displayed in *AM/PM* format. To change the format, see the *Time Format* section on the following page.)

To accept the displayed time, press **<ENTER/START>**. To change the time, use the numeric keys to enter the new time, and the arrow keys to toggle between *AM* and *PM*. Press **<ENTER/START>**. The gauge sets the time and returns to the *Clock/Calendar* menu.

### CHANGE DATE

To change the date, press **<2>** at the *Clock/Calendar* menu. The gauge displays:

01/08/2014  
mm/dd/yyyy  
Input Date and  
Press **<ENTER>**

(Note that in this example, the time is displayed in *mm/dd/yyyy* format. To change the date format, refer to the *Date Format* section below.)

To accept the displayed date, press **(ENTER/START)**. To change the date, use the numeric keys to enter the new date. When finished, press **(ENTER/START)**. The gauge sets the date and returns to the *Clock/Calendar* menu.

## **TIME FORMAT**

The gauge can display the time in either *AM/PM* or *24-hour* format. To select the desired time format, press **(3)** at the *Clock/Calendar* menu. The gauge displays:

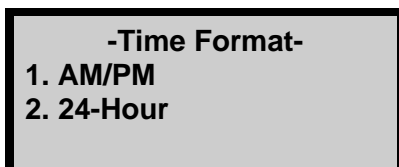

Use the numeric keys to select the desired time format. The gauge sets the time format and returns to the *Clock/Calendar* menu.

## **DATE FORMAT**

The gauge can display the date in either *mm/dd/yyyy* or *dd/mm/yyyy* format, where *mm* is the month, *dd* is the day, and *yyyy* is the year. To change the date format, press **(4)** at the *Clock/Calendar* menu. The gauge displays:

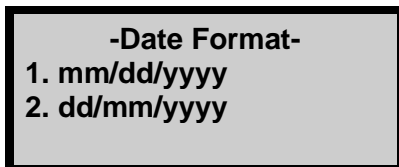

Use the numeric keys to select the desired format. The gauge sets the date format and returns to the *Clock/Calendar* menu.

## User ID

The gauge can store a three-character alphanumeric *user ID* with each measurement. To enter or change the user ID, press **<2>** at the *Extended* menu. The gauge displays:

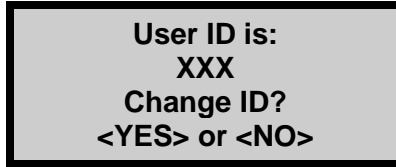

User ID is:  
XXX  
Change ID?  
<YES> or <NO>

To change the user ID, press **<YES>**. The gauge displays:

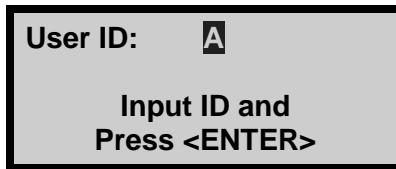

User ID: **A**  
Input ID and  
Press <ENTER>

Press the **<ALPHA LOCK>** key to enable the alphabetic keys on the gauge. When the alphabetic keys are enabled, the symbol **A** appears in the upper right of the display, as shown above.

Enter the new user ID and press **<ENTER/START>**. The gauge stores the new user ID and returns to the *Extended* menu.

## Customer Name

The gauge can store a customer name of up to 12 alphanumeric characters. To enter a customer name, press **<3>** at the *Extended* menu. The gauge displays the current customer name on the second line.

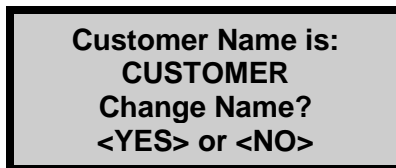

Customer Name is:  
CUSTOMER  
Change Name?  
<YES> or <NO>

To change the customer name, press **<YES>**. The gauge displays:

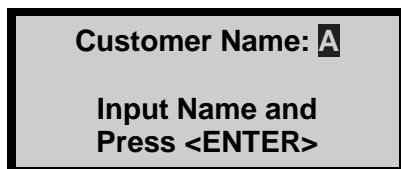

Press the **<ALPHA LOCK>** key to enable the alphabetic keys on the gauge. When the alphabetic keys are enabled, the symbol **A** appears in the upper right of the display, as shown above.

Enter the new name and press the **<ENTER/START>** key. The gauge stores the new customer name, then returns to the *Extended* menu.

Press **<ESC>** twice to return to the *Ready* screen.

## Setting the Measurement Mode

The gauge provides two measurement modes (*Soil* and *Asphalt*) for precise readings on base asphalt, concrete, soil, soil-stone aggregate, and similar materials. The gauge can also be used to determine the density of thin-layer overlays using the *Nomograph* function described on page 5–9.

Before taking a measurement, select the appropriate measurement mode by pressing the **<MODE>** key. The gauge displays:

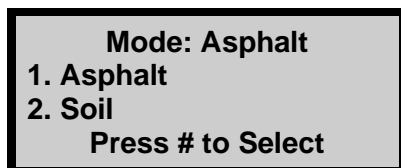

### NOTE

The **<MODE>** key is active only when the *Ready* screen is displayed.



# Chapter 4:

## Using the Gauge

---

This chapter covers the following topics and tasks:

- ✓ Taking a standard count
- ✓ Preparing a test site
- ✓ Taking measurements
- ✓ Using the Recall function

# Taking the Standard Count

---

The Model 3440 gauge uses a Cesium-137 and an Americium-241:Beryllium source for taking measurements. These radioactive sources undergo a natural decay process, resulting in a gradual loss in the intensity of their radiation. The time required for the source strength to diminish by 50% is referred to as the *half-life*.

To compensate for the source decay and to check proper operation of the gauge, a daily reference standard count should be performed. To ensure the highest accuracy possible with the gauge, it is important to take a daily standard count.

The gauge is equipped with a reference standard block for taking the standard count.

## Site Requirements

Choose a standard count site that meets the following criteria:

- ◆ A smooth, dry surface such that the reference standard block does not rock.
- ◆ At least 3 meters (10 ft.) from any large vertical surface.
- ◆ At least 10 meters (33 ft.) from any other radioactive source.
- ◆ On asphalt, concrete, or compacted soil at least 10 centimeters (4 in.) thick and with a density of at least 1600 kg/m<sup>3</sup> (100 pcf).

## NOTE

Always take standard counts using the reference standard block provided with the gauge.

### To take a standard count:

1. Ensure that the gauge base and reference standard block are dry and free of debris.
2. Place the reference standard block on the standard count site.
3. Ensure the source rod is in the **SAFE** position.
4. As shown in Figure 9, place the gauge on the reference standard block, with the right side (keypad side) of the gauge against the metal butt plate.
5. From the *Ready* screen, press **<STD>**. The gauge displays standard counts for density (DS) and moisture (MS):

**Standard Count**  
DS= ####  
MS= ####  
**Take New Count?**

- ▶ To take a new standard count, press **<YES>** and follow the instructions starting at step 6 below.
  - ▶ To view the last four standard counts, press **<NO>** and follow the instructions in the *Viewing Standard Counts* section on page 4-21.
6. When taking a new standard count, the gauge displays:

**Place Gauge on  
Std. Block & Source  
Rod in SAFE Pos.  
Press <ENTER>**

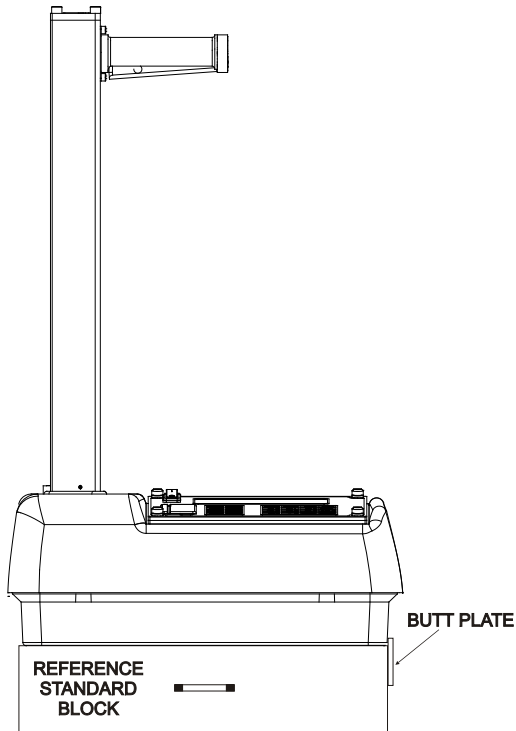

Figure 9. Standard Count Position

7. Begin the standard count by pressing the **<ENTER/START>** key. The gauge displays:

**Taking  
Standard Count  
### s  
Remaining**

8. After taking the standard count, the gauge displays the results:

**DS= #### #.#% P  
MS= #### #.#% P  
Do You Want to  
Use the New Std?**

## Recording the Standard Count

Troxler recommends keeping a daily log of the moisture and density standard counts (see Appendix E for a sample log).

To verify gauge stability, compare the daily standard count to a reliable reference as follows:

- ◆ During the first four days of operation of a new or recalibrated gauge, compare the daily standard count to the factory-calibrated values.
- ◆ After the first four days of operation (or after taking four standard counts), compare the daily standard count to the average of the last four counts. Acceptable standard count limits are:
  - ±1% each day for DS (density standard) and
  - ±2% each day for MS (moisture standard).

After recording the standard counts, press **(YES)** to return to the *Ready* mode.

### NOTE

The factory standard count values should be used as a reference if the daily standard counts are ever in question. Be sure to refer to the most recent calibration report for the gauge in question.

### If the standard count fails:

If the standard count *fails* and it has been *more than* a month since the last standard count, then do the following:

1. Accept the standard count by pressing the **<YES>** key.
2. At the **Do You Want To Erase Last Four Standard Counts?** prompt, press the **<YES>** key. The gauge displays:

**Depth Calibration  
Set Rod to BS.  
  
And Press ENTER**

3. Follow the displayed instructions, and take four additional standard counts. The last of these counts will be compared to the previous four, and the standard counts should pass. If not, repeat the procedure. If it still fails, perform a stat test (see page 5-3) and a drift test (see page 5-6), then contact your Troxler representative.

If the standard count *fails* and it has been *less than* a month since the last standard count, but the count was performed correctly and the failure is less than 5%, do the following:

1. Press the **<YES>** key. If the failure is more than 5%, press the **<NO>** key.
2. Ensure that the gauge is properly positioned on the reference standard block (see Figure 9).
3. Verify that the standard count site meets the criteria listed on page 4-16.
4. Take another standard count and accept it if it fails by less than 5%.

If the standard count fails four times, perform a stat test (see page 5-3) and a drift test (see page 5-6), then contact your Troxler representative.

After the standard count passes, the operator can take measurements with the gauge. When not taking readings, always keep the source rod in the **SAFE** position. For added user safety, the source rod automatically retracts to the **SAFE** position when the gauge is lifted using the handle.

## Viewing Standard Counts

To view the last four standard counts, press **<NO>** at the display shown at the bottom of page 4-18. The gauge displays:

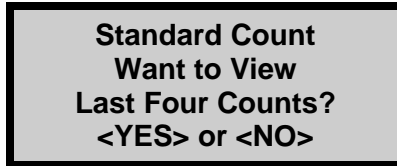

**Standard Count  
Want to View  
Last Four Counts?  
<YES> or <NO>**

- ▶ Press **<YES>** to view the last four standard counts. The gauge displays the last four density standard counts. Press **<YES>** to view the last four moisture standard counts. Press **<ENTER/START>** to return to the *Ready* screen.
- ▶ Press **<NO>** to return to the *Ready* screen.

# Site Preparation

---

Preparation of the test site surface is critical to gauge performance. This section provides site preparation procedures for both soils and base courses and asphalt surfaces. To ensure the most accurate gauge readings, the appropriate preparation procedure should be followed.

## Soil and Base Course Preparation

1. Locate a level site free from any large holes, cracks, or debris (soil surface conditions are critical to accurate measurements).
2. Smooth the surface by moving the scraper plate in a back and forth motion. Filler such as fine sand may be used to fill in the surface voids.



### CAUTION

Use only enough filler to fill the voids. Too much filler will cause an error in the measurement.

3. For direct transmission measurements, put the drill rod through the extraction tool and then through one of the guides on the plate (see Figure 10).



### WARNING

Under no circumstances should you use the source rod of the gauge to drill holes.

4. Wearing a radiation badge and safety glasses (or other locally approved safety devices), step on the plate and hammer the drill rod at least 50 mm (2 in.) deeper than the desired test depth. The drill rod increments include the additional depth.



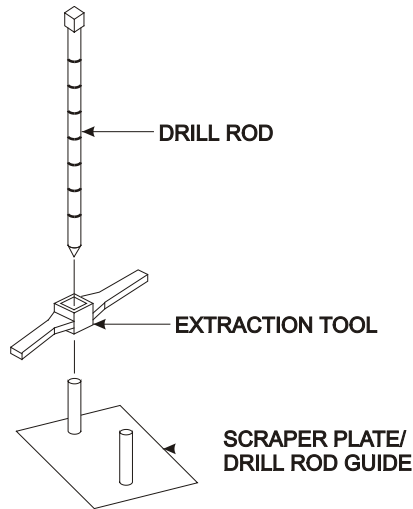

Figure 10. Drill Rod Positioning

5. Remove the drill rod by pulling straight up and twisting the extraction tool. **Do not loosen the drill rod by tapping from side to side with a hammer.** This will distort the hole or cause loose material to fall into the hole.
6. To ensure accurate placement of the gauge, before removing the scraper plate, mark the test area using the drill rod as shown in Figure 11.
7. Carefully pick up the scraper plate and place the gauge on the surface prepared by the plate. Insert the source rod into the hole made by the drill rod. **Use care when inserting the source rod; do not disturb the soil around the hole.**
8. Lower the source rod into the hole. Release the trigger and lock the source rod into the correct position. A *click* should be heard when the source rod is locked into position.
9. Gently slide the gauge toward the keypad so the source rod makes contact with the wall of the hole.

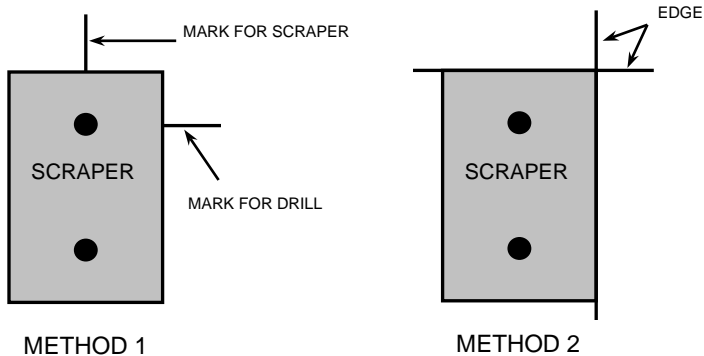

Figure 11. Marking the Test Area

## Asphalt Surface Preparation

It is possible, but usually not necessary, to take direct transmission readings on asphalt. Drilling a hole in asphalt can be difficult and may require the use of a proper drill (not the drill rod) if the asphalt has cooled and hardened.

Under normal conditions, a backscatter reading provides an accurate measurement of asphalt density. To prepare the site:

1. Find a smooth location on the asphalt. You may want to fill the voids on open mixes with sand or cement. Take care to leave the asphalt exposed. **The gauge base must rest on the asphalt, not the fill material!**
2. Ensure that the gauge does not “rock.” It must remain steady.

If rocking occurs, find a more suitable test site. If taking a measurement around a core, the gauge may be moved up to a few inches to any side of the hole.

### NOTE

These directions also apply to taking a backscatter measurement on soil.

# Taking Measurements

---

## Soil Mode

The *Soil* mode is automatically selected when a Proctor value is enabled (see page 3–9).



### CAUTION

When not taking measurements, always keep the source rod in the **SAFE** position. For added operator safety, the source rod on the gauge automatically retracts to the **SAFE** position when the gauge is lifted by the handle.

If you do not hear a *click* when the gauge is raised to the **SAFE** position, look at the bottom of the gauge to verify that the tungsten sliding block is completely closed. If the gauge base opening is not completely closed by the sliding block, the block may require cleaning. Refer to page D-10 for cleaning instructions.



### WARNING

Do not store or transport the gauge unless the sliding block is completely closed. Increased radiation levels may violate transportation regulations and cause excessive personnel exposure.

The *Status* function (see page 3–8) allows you to view selected information concerning the current gauge status and setup. To access the *Status* function, press the **(STATUS)** key. Check the gauge's current status before taking measurements.

Remember to take a standard count at least once each day the gauge is to be used (see page 4–16). Note that some states may require that a standard count be taken more frequently than once per day.

The gauge can store measurement results in files (memory locations) called *projects*. For information on creating and activating project files, refer to Chapter 8. Upon completion of a measurement, the results can be stored either automatically by enabling the *Auto-Store* function (see page 8–12) or manually by using the *Store* function (see page 8–14).

To take a measurement:

1. Select the soil mode (see **Error! Reference source not found.** on page 3–14).
2. Enter or change the Proctor value, if desired (see Chapter 6).
3. Prepare the test site (see page 4–22)
4. Place the gauge on the test area.
5. Lower the source rod into the hole made by the drill rod. Use care when inserting the source rod. Try not to disturb the soil around the hole.

Ensure that the handle stops in the notch designated for the proper measurement depth.

6. Gently slide the gauge to the right (towards the keypad) so the source rod makes contact with the wall of the hole.
7. Press **(ENTER/START)**.
  - ▶ In the *Manual* depth mode (see page 5–3), the gauge prompts for the source rod depth. Enter the source rod depth using the number keys. For example, with the source rod in the backscatter position, press **(0)**, and then press **(ENTER/START)**.
  - ▶ In the *Automatic* depth mode, the gauge software determines the source rod depth automatically.
  - ▶ Note that the Proctor value is based on soil particles 3/8" or less in diameter (or those passing a #4 sieve). If an unusual reading is obtained and oversize particles are suspected, rotate the gauge 90°. Use the same drill hole to take a second reading.

8. After the count time has elapsed, the gauge displays the measurement results in a series of three screens. Use the up and down arrows to scroll through the various screens.

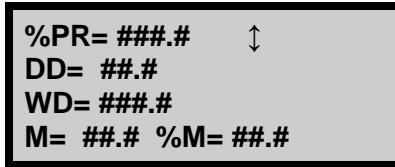

**%PR= ###.#**    **↑**  
**DD= ##.#**  
**WD= ###.#**  
**M= ##.# %M= ##.#**

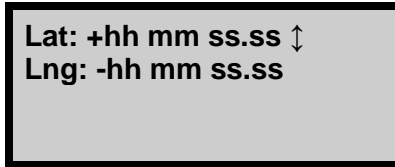

**Lat: +hh mm ss.ss** **↑**  
**Lng: -hh mm ss.ss**

where:

- %PR** = percent Proctor
- %M** = percent moisture
- DD** = dry density
- Lat** = latitude
- WD** = wet density
- Lng** = longitude
- M** = moisture

## NOTE

The latitude and longitude display, showing the location of the measurement, is available only on Model 3440 gauges equipped with the optional GPS and is shown only when it is enabled.

The latitude and longitude values denote the quality of the location fix. If WAAS information is available during a gauge measurement, the latitude and longitude will be displayed to the nearest hundredth (1/100) of a second.

If a GPS location is determined, but the WAAS information is unavailable, the latitude and longitude will be displayed to the nearest tenth (1/10) of a second.

If the GPS receiver cannot determine a location, the latitude and longitude will be denoted as 0. For more information on GPS accuracy, see Appendix H.

If a project is active and the *Auto-Store* function (see page 8–12) is enabled, press **<ESC>** or **<ENTER/START>** to continue. For each measurement, the gauge can store a location description of up to 12 characters, as well as a note of up to 15 characters. Follow the prompts to enter location information and/or a note.

If a project is active but the *Auto-Store* function is not enabled:

- ▶ Press **<STORE>** to store the results. Follow the prompts to enter location information and/or notes. For more information on storing results manually, see page 8–14.
- ▶ Press **<ESC>** to return to the *Ready* screen without storing the results. Note that, until another measurement has been taken, the results can be recalled as described on page 4–31 and stored later.

9. Lift the gauge from the test site by the source rod handle. This returns the source rod to the **SAFE** position, where it should stay when not taking readings.

## Asphalt Mode

The *Asphalt* mode is automatically selected when a Gmb value is enabled (see page 3–9).

To measure the density of asphalt (and hardened concrete of 4 inches or more), follow the steps below:

1. Select the Asphalt mode (see page 3–14).
2. Enter or enable the Marshall value and/or voidless density value (see Chapter 6).
3. Prepare the test site as described on page 4–22.
4. Place the gauge on the test area.
5. Lower the source rod to the backscatter position (just below the **SAFE** position). Release the trigger.
6. Gently push the handle down to lock the source rod into position. You should hear a *click* when the source rod locks into position.
7. Press the **<START>** key.
  - ▶ In the *Manual* depth mode (see page 5–3), the gauge prompts for the source rod depth. Enter the source rod depth using the number keys. For example, with the source rod in the backscatter position, press **<0>**, and then press **<ENTER/START>**.
  - ▶ In the *Automatic* depth mode, the gauge software determines the source rod depth automatically.
8. After the count time has elapsed, the gauge displays the measurement results in a series of three screens, Use the up and down arrows to scroll through the various screens.

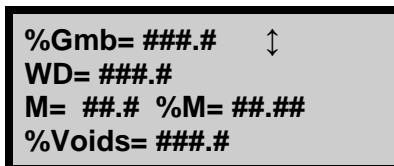

The screenshot shows a grey rectangular display area with a black border. It contains four lines of text: the first line is "%Gmb= ###.#" followed by a vertical double-headed arrow; the second line is "WD= ###.#"; the third line is "M= ##.# %M= ##.##"; and the fourth line is "%Voids= ###.#".

Lat: +hh mm ss.ss ↑  
Lng: -hh mm ss.ss

where:

**%Gmb** = percent of laboratory bulk density

**WD** = wet density

**M** = moisture value

**%M** = percent moisture

$$\% \text{ Voids} = 100 \times \left( 1 - \frac{WD}{\text{Voidless}} \right)$$

*(displayed only when enabled)*

**Lat** = latitude

**Lng** = longitude

## NOTE

The latitude and longitude display, showing the location of the measurement, is available only on Model 3440 gauges equipped with the optional GPS and is shown only when it is enabled.

The latitude and longitude values denote the quality of the location fix. If WAAS information is available during a gauge measurement, the latitude and longitude will be displayed to the nearest hundredth (1/100) of a second.

If a GPS location is determined, but the WAAS information is unavailable, the latitude and longitude will be displayed to the nearest tenth (1/10) of a second.



If the GPS receiver cannot determine a location, the latitude and longitude will be denoted as 0. For more information on GPS accuracy, see Appendix H.

If a project is active (see **Error! Reference source not found.**) and the *Auto-Store* function (see page 8–12) is enabled, press **<ESC>** or **<ENTER/START>** to continue. For each measurement, the gauge can store a location description of up to 12 characters, as well as a note of up to 15 characters. Follow the prompts to enter location information and/or a note.

If a project is active but the *Auto-Store* function is not enabled:

- ▶ Press **<STORE>** to store the results. Follow the prompts to enter location information and/or notes. For more information on storing results manually, see page 8–14.
  - ▶ Press **<ESC>** to return to the *Ready* screen without storing the results. Note that, until another measurement has been taken, the results can be recalled as described on page 4–31 and stored later.
9. Lift the gauge from the test site by the source rod handle. This returns the source rod to the **SAFE** position. When not taking readings, always keep the source rod in the **SAFE** position.

## Recall

---

To view the results of the most recent measurement, press the **<RECALL>** key from the *Ready* screen. The *Recall* function can also be used to view the gauge counts from the most recent measurement.

To return to the *Ready* screen, press the **<ENTER/START>** key.

### NOTE

The **<RECALL>** key is active only when the *Ready* screen is displayed.

# NOTES

# Chapter 5:

# Setup Menu

---

This chapter covers the following topics and tasks:

- ✓ Overview of the Setup menu
- ✓ Taking a stat test
- ✓ Taking a drift test
- ✓ Using the Nomograph function
- ✓ Using the Precision function
- ✓ Overview of optional features

# Setup Menu

---

The gauge software groups most of the setup features into one menu. To access the *Setup* menu, press the **<SETUP>** key. The gauge displays:

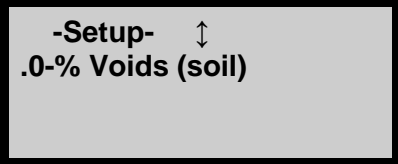
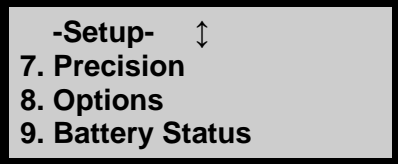
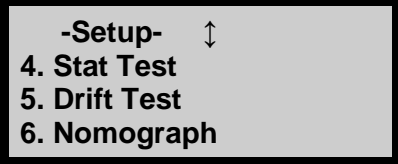
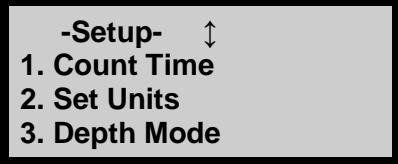

## NOTE

The **<SETUP>** key is active only when the Ready screen is displayed.

Use the arrows keys to scroll through the menu screens. To select a menu option, use the number key that corresponds to that option. The remainder of this section provides details on the functions available from the *Setup* menu.

## Count Time

The gauge provides three different count times for taking measurements. To change the count time, see page 3–8.

## Set Units

The gauge can display measurement results in either U.S. units (pcf) or metric (SI) units ( $\text{kg}/\text{m}^3$  or  $\text{g}/\text{cm}^3$ ). To change the units, see page 3–9.

## Depth Mode

The Model 3440 gauge offers two depth modes: *Automatic* and *Manual*. The *Depth Mode* function allows the operator to set the depth mode, as described on page 3–9.

## Stat Test

---

Erratic readings, or readings that seem to fluctuate, may indicate a problem with the gauge. If the readings are suspect, perform a *stat test*, or statistical stability test, to validate the normal operation of the gauge.

A stat test consists of twenty 1-minute counts. From the twenty counts, the gauge calculates the standard deviation. This standard deviation is compared to a theoretical standard deviation value. Ideally, this ratio should be 0.25, with acceptable limits from 0.17 to 0.33.

The gauge is considered unstable if the ratio is outside these limits and the stat test will fail. If the stat test fails, ensure that the gauge setup and testing was conducted correctly, and take an additional test. If the second test fails, contact the nearest Troxler service center for assistance.

For a list of Troxler and authorized Troxler service centers, refer to page *iii* of this manual or visit the Troxler website at: [www.troxlerlabs.com/services](http://www.troxlerlabs.com/services).

To access the *Stat Test* function, press **<4>** at the *Setup* menu. The gauge displays the *Stat Test* menu:

**1. Take STAT Test**  
**2. Review STAT Test**  
**3. Print STAT Test**  
**<ESC> to Exit**

To select a menu option, press the corresponding numeric key or press **<ESC>** to return to the *Setup* menu.

## Taking a Stat Test

Choose an area free of other nuclear gauges or radioactive sources. Place the gauge on the reference standard block as shown in Figure 9 on page 4–18.

To take a new stat test, press **<1>** at the *Stat Test* menu shown above. The gauge prompts the operator to place the gauge on the reference standard block with the source rod in the **SAFE** (shielded) position. Ensure that the gauge is properly positioned and press the **<ENTER/START>** key.

The gauge displays the progress of the stat test (twenty 1-minute counts). Upon completion of the counts, the gauge displays the results of the density stat test, including an indication of whether the test passed or failed:

**Density Stat Test**  
**Avg. Counts: #####**  
**R: #.### (PASS)**  
**<ENTER> for Moist.**

Press **<ENTER/START>** to view the results of the moisture stat test. Follow the prompts to scroll through the results.

## Reviewing the Stat Test

To review the results of the last stat test, press **<2>** at the *Stat Test* menu shown on page 5-3. The gauge displays the results of the density stat test as shown above. Press **<ENTER/START>** to view the results of the moisture stat test. Follow the prompts to scroll through the results.

## Printing the Stat Test

To print the results of the last stat test to a serial printer or computer via the gauge's 9-pin serial port, press **<3>** at the *Stat Test* menu shown on page 5-3. The gauge prompts the operator to connect the printer to the gauge.

Connect the serial cable to the printer or computer serial port. Press **<ENTER/START>**. The gauge prints or uploads the stat test data and returns to the *Stat Test* menu.

### NOTE

**You can purchase a serial cable from Troxler; contact your representative to order part number 113128.**

# Drift Test

---

If the gauge passes the stat test, but shows long-term drift between measurements, perform a *drift test* to check the long-term drift of the gauge. A drift test consists of five counts taken three to eight hours after a stat test ***with no movement of the gauge between tests.***

The gauge sets the pass/fail limits based on the percent difference between the average of the stat test and drift test results. If the percent difference exceeds 0.5 percent for density counts or 1 percent for moisture counts, then the drift test fails.

If the drift test fails, ensure that the gauge setup and testing were conducted correctly, and take an additional test. If the second test fails, contact the nearest Troxler service center for assistance.

For a list of Troxler and authorized Troxler service centers, refer to page *iii* of this manual or visit the Troxler website at:

[www.troxlerlabs.com/services](http://www.troxlerlabs.com/services).

## NOTE

The drift test consists of five 4-minute counts, whereas the stat test consists of twenty 1-minute counts. Therefore, each test takes approximately 20 minutes to conduct.

**DO NOT** turn the gauge off between a stat test and a drift test.

**DO NOT** move the gauge between the stat and drift tests to eliminate possible failure due to positioning changes.



To access the *Drift Test* function, press **<5>** at the *Setup* menu. The gauge displays the *Drift Test* menu:

**1. Take Drift Test**  
**2. Review Drift Test**  
**3. Print Drift Test**  
**<ESC> to Exit**

To select a menu option, press the corresponding numeric key or press **<ESC>** to return to the *Setup* menu.

## Taking a Drift Test

To take a new drift test, press **<1>** at the *Drift Test* menu. The gauge prompts the operator to place the gauge on the reference standard block with the source rod in the **SAFE** (shielded) position. Ensure that the gauge is properly positioned and press the **<ENTER/START>** key.

### NOTE

If it has been less than three hours or more than eight hours since the last stat test, the gauge displays an error message. Press **<ENTER/START>** to return to the *Setup* menu.

The gauge displays the progress of the drift test (five 4-minute counts). Upon completion of the counts, the gauge displays the results of the density drift test, including an indication of whether the test passed or failed:

**Density Drift Test**  
**Avg. Counts: ####**  
**R: #.### (Pass)**  
**<ENTER> for Moist.**

Press **<ENTER/START>** to view the results of the moisture drift test. Follow the prompts to scroll through the results.

## Reviewing the Drift Test

To review the results of the drift stat test, press **⟨2⟩** at the *Drift Test* menu. The gauge displays the results of the density drift test.

Press **⟨ENTER/START⟩** to view the results of the moisture drift test. Follow the prompts to scroll through the results.

## Printing the Drift Test

To print the results of the last drift test to a serial printer or computer via the gauge's 9-pin serial port, press **⟨3⟩** at the *Drift Test* menu. The gauge prompts the operator to connect the printer to the gauge.

Connect the serial cable to the printer or computer serial port. Press **⟨ENTER/START⟩**. The gauge prints or uploads the drift test data and returns to the *Drift Test* menu.

### NOTE

You can purchase a serial cable from Troxler; contact your representative to order part number 113128.

# Nomograph

---

In some cases, the gauge may be used to determine the density of thin asphalt overlays. This measurement may be performed with the gauge in backscatter mode and using the *Nomograph* method of density measurement. It should be noted that this method is not as accurate as a true thin-layer gauge. However, this method may produce satisfactory results under many conditions.

When a nuclear gauge is used in backscatter mode on overlays under 3 in. (7.5 cm), several effects must be overcome to produce an accurate reading. With most gauges, the primary problem is the result of photons from the source penetrating deeper than 3 in. (7.5 cm) and scattering back to the gauge. These backscattered photons from the underlying material will adversely influence the reading.

Obtaining an accurate overlay density with the *Nomograph* method requires that the density of the bottom layer and the thickness of the top layer be determined. The simplest method of determining the density of the bottom layer is to take a nuclear gauge measurement prior to applying the top layer or overlay. With the overlay applied and compacted, the depth of the layer should be determined. At this time, the gauge may be used to calculate the overlay layer density.

To access the *Nomograph* function, press **<6>** at the *Setup* menu. The gauge displays:

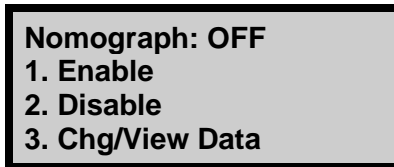

From this menu, the operator may enable, disable, or change the *Nomograph* function, as described in the following sections.

## Enable Nomograph

To enable the *Nomograph* function, press **<1>** at the *Nomograph* menu. The gauge enables the function, displays a brief confirmation message, and returns to the *Setup* menu.

## Disable Nomograph

To disable the *Nomograph* function, press **<2>** at the *Nomograph* menu. The gauge disables the function, displays a brief confirmation message, and returns to the *Setup* menu.

## Change/View Nomograph Data

To change or view the Nomograph data, press **<3>** at the *Nomograph* menu. The gauge displays:

**Thickness: #.## in  
Density: ##.# pcf  
Do You Want to  
Change?**

- ▶ To return to the *Setup* menu without changing the Nomograph data, press **<NO>**.
- ▶ To change the Nomograph data, press **<YES>**. The gauge displays:

**Select Method of  
Entering Density  
1. Keypad  
2. Measure**

The wet density of the underlying or base material may be entered either manually using the keypad or by using the gauge to record actual measurements.

## Entering Density Using the Keypad

To enter the density using the keypad, press **<1>** at the *Select Method of Entering Density* display. The gauge displays:

**Overlay Thickness**  
**### in**  
**Input and <ENTER>**

Enter the thickness of the overlay (0–10 in.) and press **<ENTER/START>**. The gauge displays:

**Bottom Density**  
**## pcf**  
**Input and <ENTER>**

Enter the wet density of the bottom layer. The gauge enables the *Nomograph* function using the entered values, displays a brief confirmation message, and returns to the *Setup* menu.

## Entering Density Using Gauge Measurements

Bottom density values may be obtained by using the gauge to record up to 20 actual measurements. To enter the density using this method, press **<2>** at the *Select Method of Entering Density* menu. The gauge displays:

**# of Readings to**  
**Average (1-20)?**  
**#**  
**Input and <ENTER>**

Enter the number of readings to be taken and averaged, then press **(ENTER/START)**. The gauge displays:

**Readings: #  
Time: # m  
Place Rod to BS &  
Press <START>**

Prepare the site for measurement as described on page 4–22. Position the gauge and press **(ENTER/START)**. The gauge displays:

**Nomograph  
Reading: 1  
Depth: BS  
Time: ## s**

After counting down to zero, the gauge displays:

**Reading: 1  
WD= ### pcf  
Move Gauge and  
Press <START>**

If more than one reading is to be taken, move the gauge to the next location and press **(ENTER/START)**. The gauge will repeat the above sequence for each reading. When all the readings are completed, the display will be:

**Average of #  
Readings  
### pcf  
Press <ENTER>**

Press **(ENTER/START)** to continue. The gauge enables the *Nomograph* function, displays a brief confirmation message, and returns to the *Setup* menu.

## Taking Nomograph Measurements

When the *Nomograph* function is enabled, the gauge can be used to take thin-layer overlay measurements. Press **<ENTER/START>** to begin the test. The gauge displays:

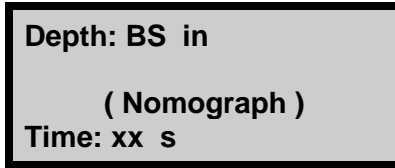

Depth: BS in  
( Nomograph )  
Time: xx s

After counting down to zero, the display is:

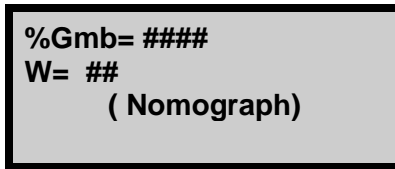

%Gmb= ####  
W= ##  
( Nomograph )

This test may be stored as any other test measurement. The recall function and/or printout will show that the *Nomograph* function was used.

### NOTE

The Nomograph function should be disabled before taking any measurements not requiring this function.

# Precision

---

The gauge can produce test results with precision limits as low as 0.1 pcf (1.6 kg/m<sup>3</sup>) under certain conditions. The *Precision* function is used to determine the count time required to achieve the precision entered by the operator. If the precision requested is within range and the time required to calculate the required result does not exceed 60 minutes, the following procedure can usually produce the required results.

To execute the *Precision* function, first ensure that the gauge is in the correct mode: *Soil* or *Asphalt*. Press **<7>** from the *Setup* menu. The gauge displays:

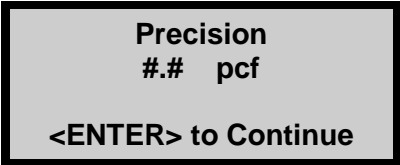

Enter the desired precision and press **<ENTER/START>**. The gauge displays:

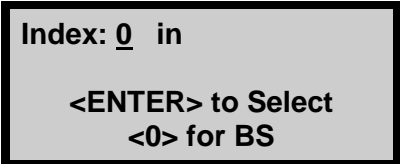

If the gauge is in the correct position, press **<ENTER/START>**. The gauge displays:

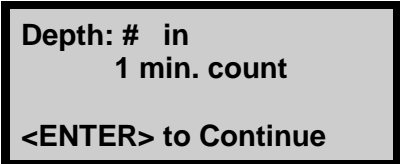



Press **<ENTER/START>**. The gauge displays:

```
Precision Mode
Depth: # in
Time: ## s
      # min. count
```

After counting down to zero, the display is:

```
## min. to
Reach precision.
<ESC> to Abort
<ENTER> to Continue
```

To abort this operation and return to the *Setup* menu, press **<ESC>**. To continue with the *Precision* function, press **<ENTER/START>**. After counting down, the display is:

(For *Soil* mode)

```
%PR= ###.#
DD= ###.#
WD= ###.#
M= ##.# %M= ##.#
```

(For *Asphalt* mode)

```
%Gmb= ###.#
WD= ###.#
M= ##.# %M= ##.#
%Voids= ###.#
```

## NOTE

If the required precision cannot be reached in 60 minutes, the gauge halts the count and displays a warning message.

# Options

---

The Model 3440 gauge offers the following optional features that may be added to the gauge. These features can be toggled on and off from the *Options* menu, accessed by pressing **(8)** from the *Setup* menu.

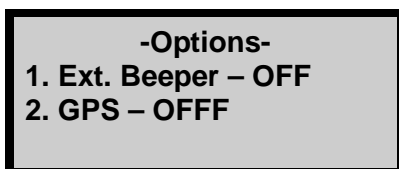

## Remote Start Keypad

If the optional remote start keypad is installed on the 3440 there will be **(START)** and **(ESC)** keys at the top of the triangular extrusion near the handle. Use these keys in the same way they would be used on the typical keypad. **(START)** will begin a reading and **(ESC)** will clear the screen to return to the *Ready* screen.

## External Beeper

The Model 3440 can be equipped with an external beeper. The external beeper alerts the operator when a measurement count is completed and is easily heard on noisy jobsites.

If available, the external port is visible near the triangular tower where the source rod goes into the gauge body. The beeper cover should be turned (closed) in dusty environments to reduce particles that may enter the gauge base. This can be toggled off if desired under the *Options* menu.

## Languages

The Model 3440 is available in English, French and Spanish. This option is typically chosen at the time of purchase and enabled at the factory. If you are interested in the Spanish or French software, keypad, and operator manual, please contact your Troxler representative to discuss this option.

## Backlit Keypad

This option allows the keypad to be seen more easily in dimly lit environments. To activate the keypad backlight, press the **<Light>** key. Using the backlight reduces battery life, so it is important to turn it when not in use.

## GPS Option

The Model 3440 gauge can also be equipped with an optional global positioning system (GPS) receiver. The GPS receiver enables the gauge to store precise GPS coordinates, along with the standard date and time stamp, for each measurement.

To toggle the *GPS* function on or off, press **<2>** on the *Options* menu shown above.

### NOTE

When the GPS option is installed and enabled, the symbol **g** appears in the upper right of the Ready screen when the gauge is receiving GPS satellite signals.

### NOTE

If a Model 3440 equipped with the GPS option is moved a long distance between uses, the GPS system must be allowed to initialize. In some instances, initialization may take as long as 30 to 45 minutes from the time the gauge is powered on with the GPS enabled. Note also that the gauge must be positioned such that the GPS receiver can receive signals from the GPS satellites (see Appendix H for more information). If the GPS does not initialize within 45 minutes, contact your Troxler representative.

# Battery Status

The *Battery Status* function displays the voltage of the NiMH batteries. To access this function, press **<9>** at the *Setup* menu.

For more information, see the *Battery Status* section on page C-11.

# Percent Air Voids (Soil Mode)

---

The gauge uses the specific gravity function to calculate percent air voids and void ratio in *Soil* mode only. The *% Voids* function allows the operator to enter the specific gravity of a material and disable or enable the percent air voids display.

## NOTE

To display percent air voids in Asphalt mode, enter a voidless density target value (see the Target Values section on page 6-3).

To access the *% Voids* function, press **<.>** **<0>** at the *Setup* menu. The gauge displays:

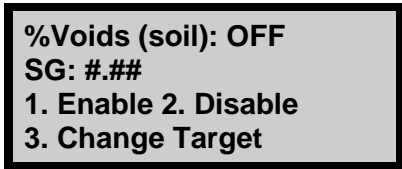

The current specific gravity (default 2.70) is shown on the second line of the display. For optimum results, use a specific gravity value that is appropriate for the material being measured.

- ▶ To enable the current specific gravity value, press **<1>**. The gauge enables the value, displays a brief confirmation message, and returns to the *Setup* menu.
- ▶ To disable the current specific gravity, press **<2>**. The gauge disables the value, displays a brief confirmation message, and then returns to the *Setup* menu.

- ▶ To enter a new specific gravity value, press **⟨3⟩**. The gauge prompts the operator for a new specific gravity. If the displayed specific gravity is acceptable, press the **⟨ENTER/START⟩** key. To change the value, use the numeric keys to do so, then press the **⟨ENTER/START⟩** key. In either case, the gauge enables the value, displays a brief confirmation message, and then returns to the *Setup* menu.

# NOTES

# Chapter 6:

## Target Menu

---

This chapter covers the following topics and tasks:

- ✓ Overview of the Target menu
- ✓ Enabling and disabling the target value
- ✓ Storing a new target value

# Target Menu

---

The Model 3440 gauge uses operator-specified *target values* to determine the percent compaction after determining the density of the test material. Target values include *Gmb (Marshall)*, *Proctor*, and *Gmm (Voidless density)* values.

The gauge uses the Marshall and/or voidless density values to calculate the compaction level in the *Asphalt* mode. The *voidless density* is the maximum theoretical density for the test material as obtained in laboratory tests. When enabled, the voidless density is used to determine the percent air voids.

The gauge uses the Proctor value to calculate the compaction level when taking measurements in the *Soil* mode.

The *Target* function enables you to enter and store a new target value, as well as enable or disable a target value stored in memory.

To access the *Target* menu, press the **<TARGET>** key. The gauge displays:



## NOTE

The **<TARGET>** key is active only when the Ready screen is displayed.

To edit a Marshall, Proctor, or voidless density value, press the number key that corresponds to the target value.



# Target Values

---

## NOTE

Because the menus for managing the Gmb (Marshall), Proctor, and Gmm (Voidless density) values are essentially the same, the following sections describe only the Gmb (Marshall) menu.

To edit a Marshall, Proctor, or voidless density value, press the number key that corresponds to that target value, as shown on the *Target* menu. For example, to edit the Gmb (Marshall) value, press **<1>**.

The gauge displays the selected *Target Value* menu. The menu for the Gmb (Marshall) value is:

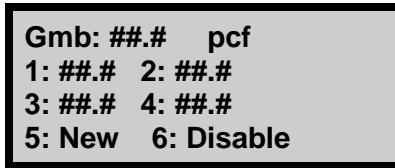

The image shows a rectangular menu box with a black border. The text inside is as follows:

<b>Gmb: ##.#</b>		<b>pcf</b>
<b>1: ##.#</b>	<b>2: ##.#</b>	
<b>3: ##.#</b>	<b>4: ##.#</b>	
<b>5: New</b>	<b>6: Disable</b>	

The *Target Value* menu shows the target values stored in memory (if any) and the *New* and *Disable* options.

## Enable a Target Value

To enable a target value displayed on the *Target Value* menu, press the corresponding number key. The gauge enables the target value and returns to the *Ready* screen.

## Store a New Target Value

To store a new target value, press **<5>** at the *Target Value* menu.

At the prompt, use the number keys to enter the target value (between 20.0 and 200.0). Press the **<ENTER/START>** key. The gauge displays:

A rectangular box with a black border containing the text: **Gmb: ##.# pcf**  
**Save This Value**  
**For Later Use?**

- ▶ To enable and use this value without storing it for later use, press **<NO>** key. The gauge enables the value and returns to the *Ready* screen.
- ▶ To enable the value and store it for later use, press the **<YES>** key. The gauge displays:

A rectangular box with a black border containing the text: **Select Memory Cell:**  
**1: ##.# 2: ##.#**  
**3: ##.# 4: ##.#**  
**Press # to Select**

The gauge can store the value in one of four *memory cells*. Storing a new value in a cell erases the old value. Use the number keys to store the value. This will replace any stored values that were previously associated with the memory cell. The gauge stores the target value, enables it for use, and returns to the *Ready* screen.

## Disable the Target Value

To disable the target value, press **<6>** at the *Target Value* menu. The gauge disables the target value and returns to the *Ready* screen.

### NOTE

The gauge can be used with the target value disabled. In this case, no percent compaction value will be displayed.



# Chapter 7:

# Calibration Offsets

---

This chapter covers the following topics and tasks:

- ✓ Overview of the offset menu
- ✓ Enabling density, moisture, and trench offsets

# About Offsets

---

The Model 3440 is factory-calibrated for soils, asphalt, and concrete with an approximate density range of 1100 to 2700 kg/m<sup>3</sup> (70 to 170 pcf). With an *offset*, you can adjust the gauge readings to correlate to traditional laboratory methods, such as core samples. The Model 3440 gauge provides three offsets: *density*, *moisture*, and *trench*.

## NOTE

When an offset has been enabled, all future readings will automatically be adjusted with the offset factor regardless of the test site. It is very important that you disable the offset function prior to taking readings on materials that do not require an offset. Offsets are disabled if the gauge is turned off for more than 10 seconds.

*Density* offsets are common when the material being measured is outside the range of 70 to 170 pcf (1121 to 2723 kg/m<sup>3</sup>) or if the material composition varies from average soil/asphalt on which the factory calibration is based.

*Moisture* offsets are required for accurate measurements if the material to be measured contains elements that can cause the gauge to yield erroneous results. A *negative* offset is required if the material to be measured is high in hydrogenous components such as cement, gypsum, coal, or lime. A *positive* offset is required if the material is high in neutron-absorbing material such as boron or cadmium.

The Model 3440 gauge requires a *trench* offset if measurements are to be taken inside a trench or close to vertical structures. Vertical structures can scatter neutrons and gamma photons back to the gauge, increasing the possibility of moisture or density errors due to high counts.

## NOTE

When the gauge is turned off, all offsets are disabled.

To access the *Offset* menu, press **<OFFSET>**. The gauge displays:

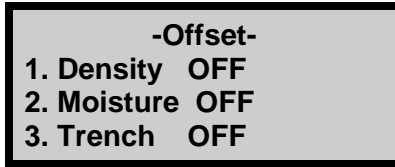

### NOTE

The **<OFFSET>** key is active only when the Ready screen is displayed.

To select a menu option, press the corresponding number key. The remainder of this chapter details the functions available from the *Offset* menu.

# Density Offset

---

To access the *Density Offset* functions, press **<1>** at the *Offset* menu.

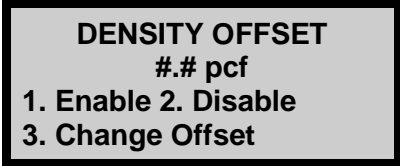

The gauge displays the current density offset on the second line.

- ▶ To enable the displayed density offset, press **<1>**. The gauge enables the offset, displays a brief confirmation message, and returns to the *Ready* screen.
- ▶ To disable the density offset, press **<2>**. The gauge disables the offset, displays a brief confirmation message, and returns to the *Ready* screen.

## NOTE

The density offset is also disabled when the gauge is turned off.

- ▶ To enter a new density offset, press **<3>**. The gauge prompts for the density offset as shown:

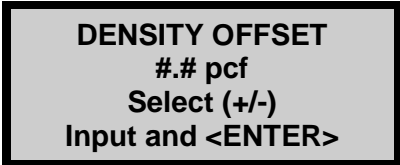

To change the offset, select the offset sign (positive or negative), enter the density offset, and press **<ENTER/START>**. The gauge enables the new density offset and returns to the *Ready* screen.



# Moisture Offset

---

The moisture offset ( $k$ ) is determined by comparing the moisture of a laboratory sample with the gauge moisture reading. The gauge allows the operator to enter the moisture offset manually, or to have the gauge derive the moisture offset. The gauge can store up to four moisture offsets.

To access the *Moisture Offset* menu, press **<2>** at the *Offset* menu shown on page 7-2. The gauge displays:

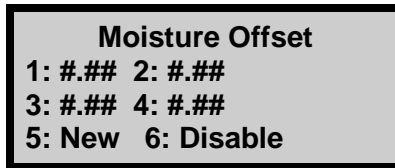

**Moisture Offset**  
1: #.## 2: #.##  
3: #.## 4: #.##  
5: New 6: Disable

The *Moisture Offset* menu shows the moisture offset values stored in memory (if any) and the New and Disable options.

## Enable a Stored Moisture Offset

To enable a moisture offset value displayed on the *Moisture Offset* menu, press the number key that corresponds to that value. The gauge enables the moisture offset value and returns to the *Ready* screen.

## Enter a New Moisture Offset

A new moisture offset may be entered either manually using the keypad or by using the gauge to record actual measurements, then entering the true moisture value as determined by an alternate method. To enter and enable a new moisture offset value, press **<5>** at the *Moisture Offset* menu shown above. The gauge displays:

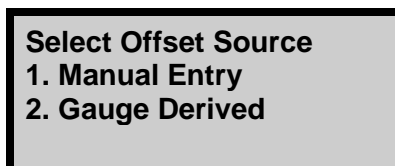

**Select Offset Source**  
1. Manual Entry  
2. Gauge Derived

## Enter a Moisture Offset (Manual Entry)

To enter a new moisture value manually via the keypad, first determine the *true moisture content* of a sample taken at the measurement site using standard laboratory methods (for example, oven drying, and so on).

Take multiple readings at or near the location where the sample was removed and record the moisture measurements. Calculate the average moisture of the readings to determine the *gauge moisture content*.

To enter the moisture offset manually, press **<1>** at the *Select Offset Source* menu shown on page 7-5. The gauge request the *true moisture value* as shown:

**True Moisture %**  
**###**  
**Press <ENTER>**

Enter the *true moisture value* and press **<ENTER/START>**. The gauge requests the *gauge moisture value* as shown:

**Gauge Moisture %**  
**###**  
**Press <ENTER>**

Enter the *gauge moisture value* and press **<ENTER/START>**. The gauge calculates and displays the moisture offset (*k*) as shown:

**K: ###**  
**Save This Value**  
**For Later Use?**

- ▶ To enable and use this moisture offset without storing it for later use, press **<NO>**. The gauge enables the offset and returns to the *Ready* screen.

- ▶ To enable the moisture offset and store it for later use, press **<YES>**. The gauge displays:

**Select Memory Cell:**  
1: ### 2: ###  
3: ### 4: ###  
**Press # to Select**

The gauge can store the value in one of four *memory cells*. Storing a new value in a cell erases the old value. Use the number keys to store the value. This will replace any stored values that were previously associated with the memory cell. The gauge stores the moisture offset, enables it for use, and returns to the *Ready* screen.

### Gauge-Derived Moisture Offset

To allow the gauge to derive the moisture offset, you must determine the *true moisture content* of a sample taken at the measurement site using standard laboratory methods (for example, oven drying, and so on), then take readings with the gauge.

To use this method of determining the moisture offset, press **<2>** at the *Select Offset Source* menu shown on page 7-5. The gauge request the *true moisture value* as shown:

**True Moisture %**  
**###**  
**Press <ENTER>**

Enter the *true moisture value* and press **<ENTER/START>**. The gauge displays:

**Place gauge on soil,**  
**lower rod and**  
**press any key**

As prompted, place the gauge on the measurement site and press any key. The gauge takes a 240-second count, during which it displays the progress of the count. Upon completion, the gauge calculates and displays the moisture offset ( $k$ ) as shown:

**K: ##.##  
Save This Value  
For Later Use?**

- ▶ To enable and use this moisture offset without storing it for later use, press **<NO>**. The gauge enables the offset and returns to the *Ready* screen.
- ▶ To enable the moisture offset and store it for later use, press **<YES>**. The gauge displays:

**Select Memory Cell:  
1: ### 2: ###  
3: ### 4: ###  
Press # to Select**

The gauge can store the value in one of four *memory cells*. Storing a new value in a cell erases the old value. Use the number keys to store the value. This will replace any stored values that were previously associated with the memory cell. The gauge stores the moisture offset, enables it for use, and returns to the *Ready* screen.

## Disable the Moisture Offset

To disable the moisture offset value, press **<6>** at the *Moisture Offset* menu. The gauge disables the moisture offset and returns to the *Ready* screen.

### NOTE

The moisture offset is also disabled when the gauge is turned off.

# Trench Offset

---

To use the gauge in a trench or within 0.6 m (2 ft.) of a large vertical surface, first perform a *trench offset*. The trench offset adjusts all moisture measurements and density measurements from backscatter to 4 inches. For direct transmission measurements over 4 inches deep, the gauge will only adjust the moisture measurements. In the displays shown below, *M* refers to *trench moisture offset*; *D* refers to *trench density offset* values.

## NOTE

**Before determining a new trench offset, ensure that a standard count has been performed recently outside the trench.**

To access the *Trench Offset* menu, press **<3>** at the *Offset* menu. The gauge displays:



The gauge displays the current offset values on the second line.

- ▶ To enable the displayed trench offset, press **<1>**. The gauge enables the offset, displays a brief confirmation message, and returns to the *Ready* screen.
- ▶ To disable the trench offset, press **<2>**. The gauge disables the offset, displays a brief confirmation message, and returns to the *Ready* screen.

## NOTE

The trench offset is also disabled when the gauge is turned off.

- ▶ To enter a new trench offset, press **<3>**. The gauge displays:

**Place Gauge in  
trench on Std.  
block in SAFE Pos.  
Press <START>**

Select a position inside the trench and the same distance from the wall as the test measurements. Place the gauge on the standard block in this position, set the source rod to the **SAFE** position, and press **<ENTER/START>**.

The gauge performs a trench count, calculates the trench moisture and density offset values, enables the trench offset, and returns to the *Ready* screen.

# Chapter 8:

## Project Data

---

This chapter covers the following topics and tasks:

- ✓ Overview of the Project menu
- ✓ Selecting and viewing projects
- ✓ Creating new projects
- ✓ Erasing projects
- ✓ Outputting and printing projects
- ✓ Deactivating projects
- ✓ Using the Auto-Store feature
- ✓ Using the Manual Store feature

# Project Menu

---

The gauge can store approximately 750 readings. The *Project* and *Store* functions allow handling of measurement data. Measurement results are stored in files (memory locations) called *projects*, which are named by the operator.

Projects are managed using the *Projects* menu. From this menu, the operator can select a project (make an existing project active so that additional data may be added to it), view project data, create a new project, erase projects, output project data to the selected destination (via the serial or USB port), deactivate a project, and enable the *Auto-Store* function.

To access the *Projects* menu, press **<PROJ>**. The gauge displays:



## NOTE

The **<PROJ>** key is active only when the Ready screen is displayed.

Use the arrow keys to scroll through the menu options. Use the numeric keys to select a menu option. Press **<ESC>** to return to the *Ready* screen.



# Select a Project

---

To select an existing project, press **<1>** at the *Projects* menu shown on page 8-2.

- ▶ If no projects have been created, the gauge displays the error message:

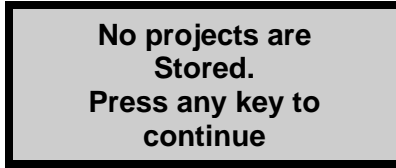

**No projects are  
Stored.  
Press any key to  
continue**

Press any key to return to the *Projects* menu, and create a project as described on page 8-5.

- ▶ If a project has been created, the gauge displays:

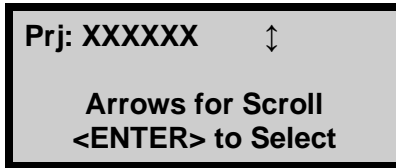

**Prj: XXXXXX    ↑  
↓**

**Arrows for Scroll  
<ENTER> to Select**

Use the arrow keys to scroll through the names of the existing projects. When the desired project is displayed, press **<ENTER/START>** to select it as active. The gauge sets the selected project as active, briefly displays a confirmation message, and returns to the *Projects* menu.

# View Project Data

---

The gauge offers two methods of viewing data. You can either view the last measurement results using the *Recall* function (see page 4–31), or any measurement results, including project notes, stored in a project file using the *View* function available from the *Projects* menu.

To view data stored in a project file, press **<2>** from the *Projects* menu. The gauge displays:

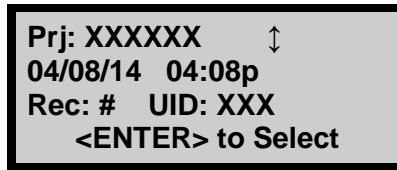

Use the arrow keys to scroll through the project names. Press **<ENTER/START>** when the gauge displays the desired project name. If any measurement data has been stored in the selected project file, the gauge displays the data for the first measurement.

Six screens of information are displayed for each measurement. Use the up and down arrows to scroll through the project data.

Press the **<ESC>** key to return to the project selection screen shown above.

# Create a Project

---

To create a new project, press **<3>** at the *Projects* menu. The gauge displays:

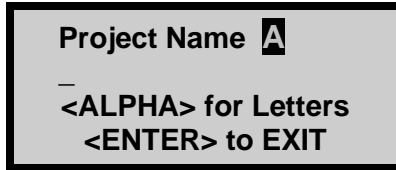

Project Name **A**  
—  
<ALPHA> for Letters  
<ENTER> to EXIT

Press the **<ALPHA LOCK>** key to enable the alphabetic keys on the gauge. When the alphabetic keys are enabled, the symbol **A** appears in the upper right of the display, as shown above.

Enter the project name (up to twelve alphanumeric characters) and press the **<ENTER/START>** key. The gauge displays:

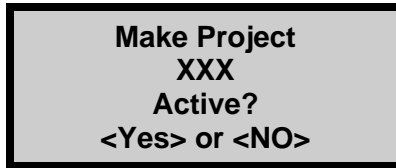

Make Project  
XXX  
Active?  
<Yes> or <NO>

- ▶ To save the new project name without activating it, press **<NO>**. The gauge saves the new project, briefly displays the name of the active project (if any), and returns to the *Projects* menu.
- ▶ To save the new project name *and* activate the project, press **<YES>**. The gauge enables the new project, displays a brief confirmation message, and returns to the *Projects* menu.

# Erase Projects

---

To erase either a selected project file or all project files, press <4> at the *Projects* menu. The gauge displays the *Erase* menu:



- ▶ To erase a single project, press <1>. If more than one project has been created, the gauge displays:

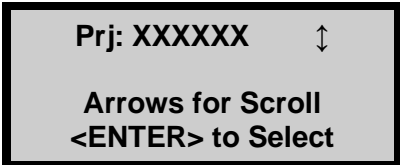

Use the arrow keys to scroll through the project names displayed on the first line. When the gauge displays the desired project, press <ENTER/START>. At the **Are you sure?** prompt, press the <YES> key. The gauge erases the project and returns to the *Projects* menu.

- ▶ To erase all projects, press <2> at the *Erase* menu. At the **Are You Sure?** prompt, press the <YES> key. The gauge erases all the projects and returns to the *Projects* menu.

# Output Project

---

The *Output Project* function within the *Projects* menu allows the operator to print or upload project data stored in the gauge to a computer or serial printer connected to the serial port, or to a USB printer or flash drive connected to the USB port. To select the output destination, see page 8–11.

## NOTE

The USB port is included only on Model 3440 gauges.

## Uploading or Printing Project Data

You can upload project data to a computer via the serial port using Troxler's Gauge Download Program, available at: [www.troxlerlabs.com/downloads/software/gaugedownload.zip](http://www.troxlerlabs.com/downloads/software/gaugedownload.zip)

You can also upload the data using Windows® HyperTerminal or TerraTerm. See the "Downloading Data" procedure at [www.troxlerlabs.com/documents](http://www.troxlerlabs.com/documents) for HyperTerminal instructions.

To output project data via the 9-pin serial port, connect a serial cable to the port. An optional serial cable, P/N 113128, is available from Troxler. Connect the serial cable to the computer's COM port (or a printer's serial port).

To output project data to a USB printer via the USB port, connect a USB cable to the USB port and connect the cable to the USB printer. To output project data to a USB flash drive, connect the flash drive directly to the USB port.

## NOTE

The opening for the USB port will accept a device with maximum dimensions of 10 mm (0.40 in.) high by 29 mm (0.79 in.) wide.

A list of compatible USB devices is available at: [www.troxlerlabs.com/documents](http://www.troxlerlabs.com/documents)

At the *Projects* menu, press **<5>**. The gauge request the output format as shown:

**Output:**  
**1. 32 Column Report**  
**2. Spreadsheet**  
**Press # to Select**

The *32 Column Report* option is formatted for a standard printer width. This format is recommended when outputting the data to a printer. The *Spreadsheet* option is sent in a *comma-delimited* format, which can then be imported easily into a spreadsheet program, such as Microsoft Excel®. Table 2 on page 8–10 defines the information contained in each column of the spreadsheet.

Press **<1>** or **<2>** to select the desired output format. The gauge displays:

**Output:**  
**1. One Project**  
**2. All Projects**  
**Press # to Select**

From this menu, the gauge can print (or upload) either a single project or all projects.

- ▶ To output a single project, press **<1>**. The gauge displays:

**Prj: XXXXXX**    ↑  
**Arrows for Scroll**  
**<ENTER> to Select**

Use the arrow keys to scroll through the project names displayed on the first line. When the gauge displays the desired project, press **<ENTER/START>**.

- ▶ To output the data from all projects, press **<2>**.

The gauge prints (or uploads) the selected project(s) and returns to the *Projects* menu. Press the **(ESC)** key to return to the *Ready* screen.

Table 2. Spreadsheet Column Definitions

A	Record Number	U	Center Line Distance
B	Time and Date	V	Gmb Target
C	Project Name	W	Gmm Target
D	User	X	Proctor Target
E	Mode:	Y	Specific Gravity
F	Units	Z	Bottom Layer Density
G	Location	AA	Top Layer Thickness
H	Notes	AB	Density Offset
I	Wet Density	AC	Moisture Offset
J	Dry Density	AD	Trench Density Offset
K	Moisture	AE	Trench Moisture Offset
L	% Moisture	AF	Model Number:
M	%Gmb	AG	Serial Number
N	%Voids	AH	Depth
O	%Proctor	AI	Time (Count Time)
P	%Voids – Soil	AJ	Density Standard Count
Q	Voids Ratio	AK	Moisture Standard Count
R	Latitude	AL	Density Count
S	Longitude	AM	Moisture Count
T	Center Line Side		



# Set Output Destination

---

As described on page 8-7, the gauge can print (or upload) project data to a computer or serial printer connected to the serial port, or to a USB printer or flash drive connected to the USB port.

## NOTE

The USB port is included only on Model 3440 gauges. A list of USB devices that are compatible with the gauge is available at: [www.troxlerlabs.com/documents](http://www.troxlerlabs.com/documents)

To select the output destination, press **<6>** at the *Projects* menu. The gauge displays:

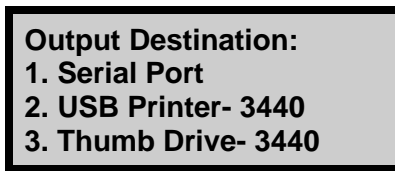

Use the numeric keys to select the desired output destination. The gauge enables the selected option, displays a brief confirmation message, and returns to the *Projects* menu. Press **<ESC>** to return to the *Ready* screen.

# Deactivate a Project

---

To deactivate the current project without selecting a different one as active, press **<7>** at the *Projects* menu. The gauge deactivates the current project, displays a brief confirmation message, and returns to the *Projects* menu. Press **<ESC>** to return to the *Ready* screen.

# Auto-Store

---

The *Auto-Store* function automatically stores sample data upon completion of a measurement. The data is stored under the active project, using a sequential sample ID number. When a new project is created, the sample ID number for the *Auto-Store* function starts at 1 and is incremented each time a new measurement is stored automatically or manually.

To access the *Auto-Store* function, press **<8>** at the *Projects* menu shown on page 8-2. The gauge displays:

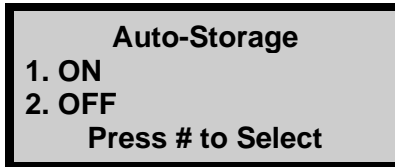

- ▶ To return to the *Projects* menu without changing the *Auto-Store* status, press **<ESC>**.
- ▶ To turn the *Auto-Store* function on, press **<1>**.
- ▶ To turn the *Auto-Store* function off, press **<2>**. The gauge updates the *Auto-Store* status, displays a brief confirmation message, and returns to the *Projects* menu.

## Active Project Selected

If you attempt to enable the *Auto-Store* function and a project has been selected as active, the gauge enables the *Auto-Store* function, briefly displays the confirmation message shown below, and then returns to the *Projects* menu.



## No Project Data

If you attempt to enable the *Auto-Store* function but no project has been created, the gauge displays:

**No Project Data  
Do You Want To  
Enable Auto-Store by  
Creating a Project?**

- ▶ To return to the *Projects* menu without enabling the *Auto-Store* function, press **⟨NO⟩**.
- ▶ To create a project and enable the *Auto-Store* function, press **⟨YES⟩**. The gauge displays the screens required to create a project as described on page 8-5. When the project name is complete, the gauge sets the project as active, displays the confirmation message shown on page 8-12, and returns to the *Projects* menu.

## No Project Selected

If the operator attempts to enable the *Auto-Store* function and one or more projects have been created, but no project has been selected as active, the gauge displays:

**Auto-Store Requires  
An Active Project:  
1. Select Project  
2. Create Project**

To select an existing project, press **⟨1⟩**. The gauge displays the screens required to select a project as described on page 8-3. After the project is selected, the gauge sets the project as active, briefly displays the confirmation shown on page 8-12, and returns to the *Projects* menu.

To create a new project, press **⟨2⟩**. The gauge displays the screens required to create a. After the project is created, the gauge sets the project as active, briefly displays a confirmation message, and returns to the *Projects* menu.

# Manual Store

---

After completing a measurement and before taking another one, sample data can be stored manually under the active project. Refer to pages 8-3 through 8-5 for instructions on creating and selecting the active project.

To manually store measurement data, press the **<STORE>** key while data is being displayed. If no project is active when the **<STORE>** key is pressed, the gauge displays the error message **No active project!**, then returns to the *Ready* screen.

## NOTE

The **<STORE>** key is active only when measurement data is displayed. Measurement data is displayed at the end of a reading, or the most recent test results can be displayed using the **<RECALL>** key (see page 4-31).

For each measurement, the gauge can store a location description of up to 12 characters, as well as a note of up to 15 characters. For an *Asphalt* mode measurement, the gauge can also store the location with respect to the centerline (left, right, or neither), and the distance from the centerline. Follow the prompts to enter location information and/or a note.

# NOTES



# Chapter 9:

## Extended Menu

---

This chapter covers the following topics and tasks:

- ✓ Setting the date and time
- ✓ Setting a user ID and customer name
- ✓ Viewing source decay information
- ✓ Erasing standard counts
- ✓ Setting the Low Battery Warning display options
- ✓ Resetting the software

# Extended Menu

---

To access the *Extended* menu, press **<SETUP>** to display the *Setup* menu, then press **<.>** **(9)**. The gauge requests an access code:

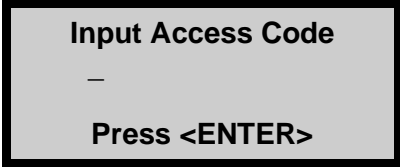

Enter the access code shown on page *xv* and press the **<ENTER/START>** key. The gauge displays the *Extended* menu:

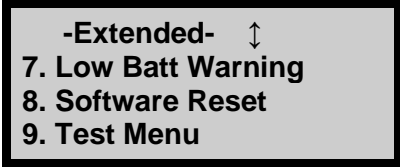
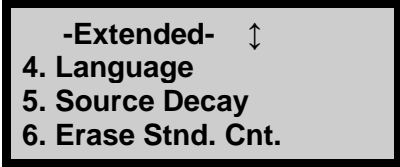
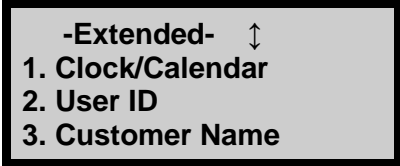

Use the up and down arrows to scroll between the menu options. To select a menu option, press the corresponding numeric key. To return to the *Setup* menu, press the **<ESC>** key.



## Clock/Calendar

---

The *Clock/Calendar* function allows the operator to change the date and time, and to select the display format for each. This function is described on page 3-10.

## User ID

---

The gauge can store a three-character *user ID* with each measurement. To enter or change the user ID, refer to page 3-13.

## Customer Name

---

The gauge can store a customer name of up to 12 characters. To enter or change the customer name, refer to page 3-13.

# Language

---

The language feature is an optional upgrade (see page 5–16). If your gauge is enabled with this option, you can access the language function by pressing **<3>** at the *Extended* menu. The gauge displays:

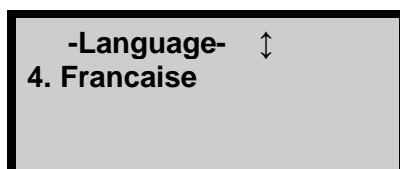
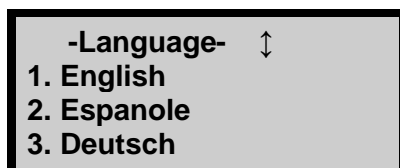

Use the up and down arrows to scroll between the menu options. To select the desired language, press the corresponding number key. To return to the *Extended* menu, press the **<ENTER/START>** or **<ESC>** key.

# Source Decay

---

The strength of radioactive material is measured by its activity, or rate of decay. This activity decreases with time. The length of time it takes a given amount of radioactive material to decay to half of its original strength is referred to as the *half-life*. The half-life of the Am-241:Be source is 432 years. The half-life of the Cs-137 source is 30 years.

The *Source Decay* function allows the operator to view how the decrease in the radiation intensity of the source affects gauge density measurements. It displays the actual density standard count, the predicted standard count, and the percent difference between the two sets of counts. The gauge calculates the predicted standard count based upon the density standard

count at the time the gauge was calibrated and the number of days that have elapsed since calibration.

To access the *Source Decay* function, press **<5>** at the *Extended* menu. The gauge displays:



A rectangular box with a black border containing the following text:

**Standard After Decay**  
**Current: ###**  
**Predicted: ###**  
**%Diff: ###**

To return to the *Extended* menu, press the **<ENTER/START>** or **<ESC>** key.

## Erase Standard Counts

---

The *Erase Standard Counts* function allows the operator or service technician to remove all (four) standard counts from gauge memory.

To execute the *Erase Standard Counts* function, press **<6>** at the *Extended* menu. The gauge displays:

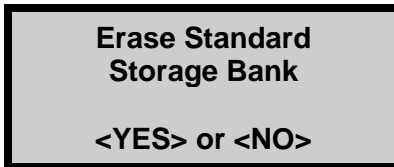

A rectangular box with a black border containing the following text:

**Erase Standard  
Storage Bank**

**<YES> or <NO>**

- ▶ To return to the *Extended* menu without erasing the standard counts stored in memory, press **<NO>**.
- ▶ To erase all the standard counts, press **<YES>**. The gauge erases the standard counts stored in memory and returns to the *Extended* menu.

# Low Battery Warning

---

The gauge constantly monitors the voltage and charge status of the NiMH batteries. The *Battery Status* function enables the operator to view the status of the NiMH batteries.

In addition, if the battery voltage falls below a pre-determined threshold, the gauge displays a low-battery warning symbol (☹) in the upper right corner of the *Ready* display.

By default (*Normal* setting), the low-battery warning is displayed when the battery voltage falls below 6.2 V dc. At that point, the gauge has approximately three hours of battery operating life left, or less if the backlight is used. If the gauge is equipped with a GPS, the remaining battery operating life will be approximately one hour.

The *Low Battery Warning* function enables the operator to select how early or late the low-battery warning is displayed. An early setting provides more time between when the warning is displayed and when the gauge shuts down. A later setting provides less warning time.

To access this function, press <7> at the *Extended* menu. The gauge displays:



Use the up and down arrows to scroll between the menu options. To select the desired low battery warning option, press the corresponding numeric key. To return to the *Extended* menu, press the **<ESC>** key.

## Software Reset

---

The *Software Reset* function sets selected user setup values (count time, measurement units, depth mode, user ID, customer name, etc.) to their factory default values.

### NOTE

The Software Reset function does not affect the calibration constants, gauge serial number, clock and calendar settings, or projects stored in the gauge memory.

To access this function, press **<7>** at the *Extended* menu. The gauge displays:

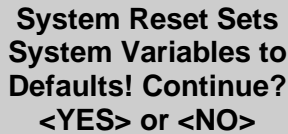

**System Reset Sets  
System Variables to  
Defaults! Continue?  
<YES> or <NO>**

- ▶ To return to the *Extended* menu without resetting system variables, press **<NO>**.
- ▶ To reset system variables to default values, press **<YES>**. The gauge resets the system variables and returns to the *Extended* menu.

## Test Menu

---

### NOTE

The functions available from the Test Menu are to be used by qualified service personnel only!

# NOTES

# Appendix A: Maintenance & Troubleshooting

---

This appendix covers the following topics and tasks:

- ✓ Troubleshooting and error messages
- ✓ Changing the display contrast
- ✓ Maintaining and servicing your gauge
- ✓ Charging and replacing the battery
- ✓ Replacement parts list
- ✓ Cleaning the gauge
- ✓ Lubricating the source rod
- ✓ Replacing the gasket and O-Ring
- ✓ Returning the gauge for service

# Troubleshooting

---

## Gauge Fails Standard Counts

1. Ensure that the source rod opening on the gauge bottom is completely closed or covered by the tungsten sliding block. If any opening is visible, the sliding block should be cleaned by the Radiation Safety Officer as described in Appendix D. If the sliding block still does not close completely, contact the nearest Troxler Service Center.
2. Ensure that the guidelines for performing the standard count listed on page 4–16 are followed.
3. Perform the standard count again. If it still fails, contact your nearest Troxler service center or representative.

## No Density Readings

The most likely reason for no density readings is an electronic problem, such as a failure of the detector preamplifier.

### CAUTION

Also, the gauge may have gotten wet. The Model 3440 and 3440 gauges are not waterproof and should not be used in the rain. If the gauge gets wet make sure it is completely dry before sealing it in the case for storage. If you suspect that moisture may be inside the gauge open the keypad panel and run a fan or hairdryer (on low) in the gauge for 15 minutes to an hour in a clean environment. .

As a precaution, ensure that the tip of the source rod is intact and undamaged. Use a radiation survey meter to check the radiation levels at the surface of the gauge base where the source rod exits (without extending the source rod). A maximum reading of 10-20 mrem/hr is normal, and indicates the source is present. If the maximum reading is less than 1 mrem/hr or if a survey meter is not available, **perform a visual**  
**Appendix A-2**



**inspection** of the source rod tip as follows to confirm its integrity.

Extend the source rod just far enough to see the source rod tip. The tip should appear flat to slightly rounded and smooth. Complete the inspection as quickly as possible and stay at least 1 meter from the rod tip to minimize exposure (the dose rate at 1 meter from the unshielded source is about 2.7 mrem/hr).

If the visual inspection indicates that the source rod tip is broken off (source is missing):

1. Immediately contact your Radiation Safety Officer (RSO).
2. Initiate a search for the source starting at the location where the gauge was last used.
3. Report lost or missing radioactive sources to your state or federal radiation control agency in accordance with applicable regulatory requirements.
4. Contact the Troxler Radiation Safety Department for further advice.

### **Gauge Readings Appear Erratic**

1. Ensure that the source rod is properly positioned in the desired measurement position. For backscatter readings, do not allow the source rod to contact the material.
2. Erratic density readings may be caused by a dirty sliding block. Clean the sliding block as instructed on page D-10 and then take readings again.
3. Check the inside of the gauge for moisture. To dry the gauge interior, remove the keypad. If necessary, use a hair dryer (on low heat) to circulate warm air for 15 minutes to 1 hour.
4. Remove any foreign objects from inside the gauge.
5. Ensure the hardware mounting screws are tight and in place.
6. Check count time – a four-minute count will give the highest precision with a repeatability of  $\pm 1$  pcf.

7. Perform a statistical stability (stat) test.
  - ▶ If test passes, proceed with job.
  - ▶ If test fails, repeat two more times. If test fails two out of three times, contact the nearest Troxler Service Center.

## NOTE

To aid in verifying gauge readings, after a gauge has been calibrated, mark a test area on a concrete floor, sidewalk, or equivalent and measure the density (WD). This measurement can then be used as a reference to verify later gauge readings.

### Unreadable, XXXX or + + + + is Displayed

1. Check the standard counts in memory. If the standard counts are suspect, perform new standard counts. If counts equal zero for both systems, replace high voltage board. Contact the nearest Troxler Service.
2. Ensure that the measurement depth (depth of the source rod handle) is the same as the depth displayed on the display before starting a measurement.
3. Check gauge for water damage. If the gauge is wet, dry the gauge interior with hairdryer (on low heat) for 15 minutes to 1 hour.
4. Check that the calibration constants are valid.
5. If necessary, perform a statistical stability (stat) test, record the results and contact the nearest Troxler Service Center.

### Gauge Turns off after it is Turned On

1. The gauge automatically turns off after five hours if no keys are pressed. Try to turn the gauge on again.
2. The gauge may be wet. Do not turn the gauge on until moisture is removed from gauge interior! Component damage may result.
3. If the battery is below 5.5 volts, recharge or replace the batteries.

4. The front panel assembly may be defective. To test, replace the suspect front panel assembly with a good front panel assembly.

### **Short Battery Life after Recharging**

1. Check that you are using the correct charger.
2. Ensure the charging indicator light (red LED) is illuminated when the gauge is plugged in.
3. NiMH batteries may be charged up to 500 full charge-discharge cycles. The batteries may be reaching end of life cycle - replace.



#### **CAUTION**

All information stored in the gauge except the calibration constants and the chosen language is lost when the batteries are disconnected.

4. Remove any loose screws or foreign objects from the gauge interior that may cause an electrical short to ground.
5. The AC charger may be defective. Check voltage output of charge with a voltmeter, or use the dc charger to charge the batteries.

### **Satisfactory Counts, but Results are in Error**

- ◆ Ensure that the handle is seated in bottom of notch.
- ◆ Ensure the measurement depth on the display screen corresponds to the actual source rod handle depth.
- ◆ Check to see if an offset (density, moisture, trench or special) is enabled.
- ◆ Ensure that the standard counts are correct.
- ◆ Check calibration constants.

## Possible Malfunction Indicators

<b>Symptom</b>	<b>Possible Malfunction</b>
Batteries discharge prematurely	HV Board
Batteries do not charge	CPU Board, Preamp Board
Battery low indicator does not function correctly	CPU Board
Beeper stops (or is erratic)	CPU Board
Display malfunctions	CPU Board
Display test Fails	CPU Board
Fails stability or drift tests	Preamp board
Gauge does not turn on when charger is connected	CPU Board
Gauge doesn't turn off	CPU Board
Gauge fails stat or drift tests	HV Board
Gauge fails tube test	Preamp board
Moisture or density counts are unstable	HV Board
No keypad response	CPU Board
No moisture or density counts	Preamp Board, HV Board

## Error Messages

The following table displays a list of the gauge error messages, as well as the possible causes and recommended solutions for each message.

Table 3. Error Messages

Error Message	Possible Causes	Solution
Bad Checksum! Default Settings Restored	Gauge settings and/or project data stored in memory have been corrupted and default (factory) settings have been restored.	Set up user preferences (such as measurement mode, count time, and so on) as described in Chapter 3.
Cannot Close File after Writing.	An error occurred when attempting to store data to a USB flash drive.	Try to store the data again. If error recurs, try a different USB flash drive.
Cannot Initialize Media	An error occurred when trying to access the USB flash drive.	Check that the USB flash drive is installed properly. If error recurs, try a different USB flash drive.
Cannot Open Printer	An error occurred when trying to communicate with a USB printer.	Check that the printer is powered on and is properly connected to the USB port. Ensure that the printer is compatible with the gauge. A list of compatible USB devices is available at: <a href="http://www.troxlerlabs.com/products">www.troxlerlabs.com/products</a>
Cannot Write to the File	An error occurred when attempting to store data to a USB flash drive.	Try to store the data again. If error recurs, try a different USB flash drive.
Cannot Write to the Printer	An error occurred when trying to communicate with a USB printer.	Check that the printer is powered on and is properly connected to the USB port. Ensure that the printer is compatible with the gauge. A list of compatible USB devices is available at: <a href="http://www.troxlerlabs.com/documents">www.troxlerlabs.com/documents</a>
Depth Sensor Error. Enable Manual Mode	A hardware problem has occurred with the depth strip.	To continue using the gauge, enable <i>Manual</i> depth mode. Contact the nearest Troxler Service Center.

Error Message	Possible Causes	Solution
Error Writing to the File	An error occurred when attempting to store data to a USB flash drive.	Try to store the data again. If error recurs, try a different USB flash drive.
Error! Stat Test Not Valid	Operator has tried to run a drift test without having a valid stat test.	Perform a stat test, and then run a drift test.
Gauge Requires Re-calibration! Contact Tech Support	The calibration constants stored in the gauge have become corrupted.	Contact the nearest Troxler Service Center.
Gmb Target Exceeds Limits!	The target value must be between 20.0 and 200.0 pcf. The operator has entered a value outside this range.	Enter a target value between 20.0 and 200.0 pcf.
Gmm Target Exceeds Limits!	The target value must be between 20.0 and 200.0 pcf. The operator has entered a value outside this range.	Enter a target value between 20.0 and 200.0 pcf.
Invalid Access Code	Operator entered an invalid access code.	Enter the correct access code (see the front of this manual).
Invalid Depth	The source rod is not at a valid depth when starting a measurement.	Ensure the source rod position is at a valid depth when starting a measurement. Contact the nearest Troxler Service Center.
Low Battery. Gauge Shutting Down. Turn off & Charge	The following three items are <b>all true</b> : the charger is not connected, the NiMH batteries are low, and the alkaline batteries need replacing.	Charge the NiMH batteries and replace the alkaline batteries.

<b>Error Message</b>	<b>Possible Causes</b>	<b>Solution</b>
Moisture Offset Exceeds Limits!	The moisture offset (k) value must be between -200 and 200. When performing a moisture offset, the resulting k value was outside of these limits	Enter a new moisture offset.
No active project!	Operator tried to store measurement data, but no project is active.	Select an existing project or create a new project and select as active.
Proctor Target Exceeds Limits!	The target value must be between 20.0 and 200.0 pcf. The operator has entered a value outside this range.	Enter a target value between 20.0 and 200.0 pcf.
Project has No Data!	Operator attempted to view a project with no data.	Select the correct project when attempting to view.
Overlay Thickness Exceeds Limits!	When using the <i>Nomograph</i> function, the overlay thickness value must be between 0 and 10 in. The operator has entered a value outside this range.	Enter an overlay thickness value between 0 and 10 in.
Warning!! Time to Reach Precision too high	When using the <i>Precision</i> function, the time required to reach the selected precision value exceeds 60 minutes.	Enter a different precision value or disable the Precision function.

# Display Contrast

---

The gauge display may be difficult to read when viewed in bright light. If so, adjust the display contrast as follows:

1. Loosen the four captive screws located in the corners of the keypad.
2. Gently lift the control unit from the gauge and tilt it forward.
3. As shown in the image below, an adjustment potentiometer for the display contrast is located inside an access hole in the back panel of the control unit.
4. Using a small screwdriver, adjust the potentiometer to obtain the desired display contrast.
5. Gently place the control unit inside the gauge and tighten the four captive screws in the corners of the keypad.

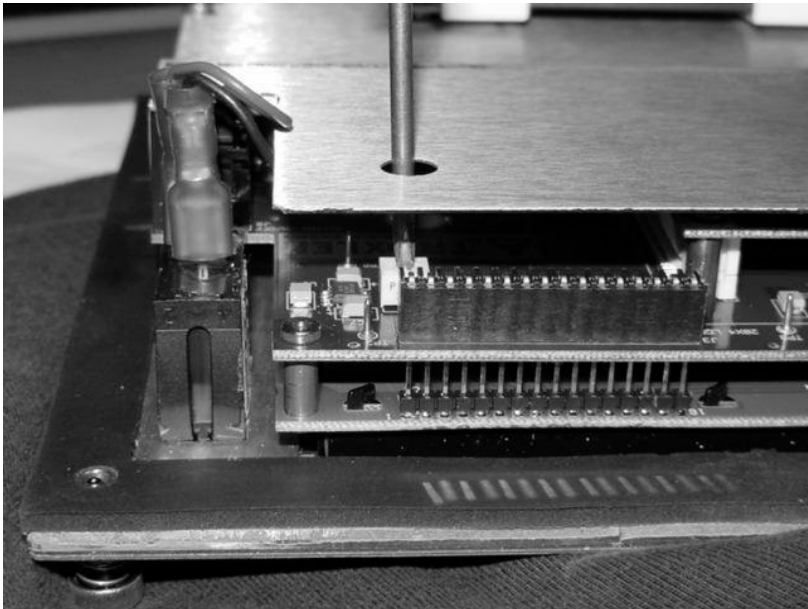

Figure 12. Adjusting the Display Contrast



# Batteries

---

The gauge is equipped with a rechargeable nickel-metal hydride (NiMH) battery pack containing five C batteries (see Figure 13). When the NiMH batteries drop below 5.5 V, the gauge shuts off. Troxler recommends recharging the NiMH batteries. The NiMH batteries can be fully recharged in only three hours.

Backup gauge power can also be supplied using the AA alkaline batteries supplied with the gauge as described.

Table 4 shows the typical operating life of a new, fully charged NiMH battery pack and a set of new AA alkaline batteries. As shown in the table, the typical battery operating life is impacted by the use of the backlight and whether or not the gauge is equipped with a GPS unit.

## Battery Status

The *Battery Status* function displays the voltage and charge status of the NiMH batteries. To access the *Battery Status* function, press **<SETUP>** to display the *Setup* menu, then press **<9>**. The gauge displays:

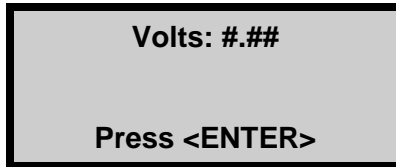

Volts: #.##

Press <ENTER>

If the battery voltage is 6.0 volts or less, recharge the batteries as described on page A-13..

Press **<ENTER/START>** to return to the *Setup* menu.

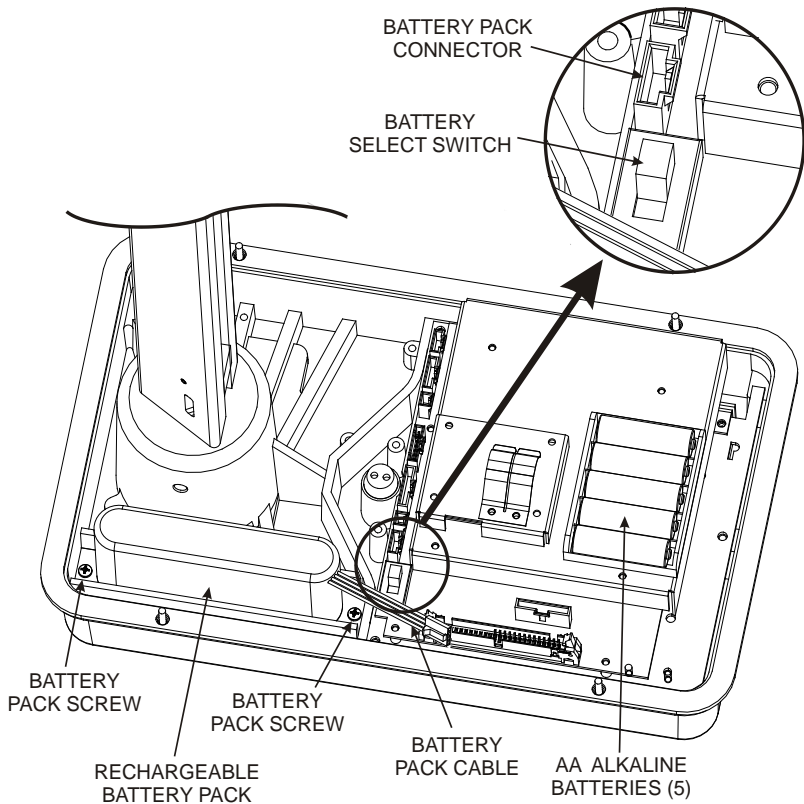

Figure 13. NiMH Battery Pack and AA Batteries

Table 4. Typical Battery Operating Life

Backlight	GPS Installed?	Typical Life, NiMH Battery Pack*	Typical Life, AA Batteries*
Off	No	110 hours	55 hours
Off	Yes	35 hours	18 hours
On	Yes	15 hours	8 hours
On	No	25 hours	13 hours

\* From full charge

# Battery Charging

---

With fully charged batteries, the Model 3440 gauge will remain operational for approximately eight weeks under normal (8-hour day) conditions.

If the batteries become discharged, the following message will be displayed on the gauge:

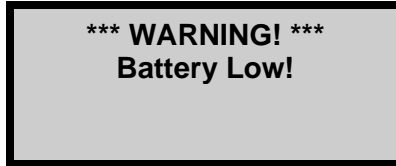

When this display appears, there are a few hours remaining before the battery must be recharged. In an emergency, a 30-minute recharge with the dc or ac charger gives several hours of use. If possible, run the batteries down before recharging.

To charge the NiMH batteries:

1. Plug the ac charger or dc adapter into the charger connector in the gauge's control panel (see Control Panel on page 3-3).
2. If using the ac charger, plug the other end of the charger into a standard 100-240 V ac outlet. If using the dc adapter, connect the other end to any 12-14 V dc source (such as a vehicle's cigarette lighter). The battery charging indicator will light.
3. To ensure a full charge, allow the batteries to charge until the battery charging indicator goes out (approximately three hours).
4. After recharging the batteries, unplug the ac charger or dc adapter and store for later use.

## NOTE

The battery select switch must be in the RECHARGEABLE position to charge the NiMH batteries.

### Replacing the NiMH Battery Pack

To replace the NiMH battery pack (P/N 110374):

1. Turn the gauge off.
2. Using a 7/64-inch Allen wrench, remove the six screws that hold the top shell to the gauge base.
3. Clean the screws and set them aside.
4. Carefully remove the gauge top shell and slide it up, out of the way. To keep the top shell out of the way, tie it to the handle.
5. Unplug the battery cable from the battery connection on the top circuit board. Gently squeeze the connector to disconnect.
6. Remove the two battery pack screws and set them aside.
7. Remove the old NiMH battery pack and install the replacement pack.
8. Replace the two screws.
9. Plug the battery cable into the battery connection on the top circuit board.
10. Re-assemble the gauge top shell.

## Installing and Using Alkaline Batteries

If your Model 3440 gauge is installed with the alkaline battery backup, you can power the gauge using five AA alkaline batteries. To install the batteries:

1. Turn the gauge off.
2. Loosen the four captive screws on the control unit.
3. Carefully lift the control unit from the gauge.
4. Unplug the ribbon cable from the control unit by pushing the levers on either side of the ribbon down.
5. Install five standard AA alkaline batteries into the battery holder.
6. Set the battery select switch to the **ALKALINE** position.
7. Plug the ribbon cable into the control unit.
8. Attach the control unit to the gauge with the four captive screws.

# Mechanical Maintenance

---

The following procedures should be performed to keep the Model 3440 gauge in good working order. If a serious problem with the gauge arises, contact the nearest Troxler Service Center or representative for instructions.

For a list of Troxler and authorized Troxler service centers, refer to the front of this manual or visit the Troxler website at [www.troxlerlabs.com](http://www.troxlerlabs.com)

## CAUTION

Personnel should wear a dosimeter to monitor radiation exposure while performing maintenance on the gauge if it is required by their radioactive materials license or local regulations.

## CAUTION – EUROPEAN COUNTRIES

Do not separate the control unit from the base. Doing so will result in non-compliance with EMC directive. Call your Troxler representative for additional information.

## Cleaning the Base and Topshell

If the Model 3440 gauge is to provide precise and accurate measurements over a long period of time the gauge should be kept as clean as possible. Monitor the outside surfaces of the instrument for accumulations of dirt, oil, asphalt, or any other foreign matter. If a build-up of material is visible on the gauge base or topshell, use the following procedures for cleaning:

To clean the gauge base, use a putty knife to scrape away any built-up accumulations of soil or asphalt. **Be careful not to damage the gauge base!** After removing any large accumulations, wipe the gauge base with a cloth soaked in BindOff, WD-40 or similar non-corrosive cleaner to remove the remaining debris.

 **CAUTION**

Cleaners and lubricants can damage the keypad. Do not allow these chemicals to make contact with the keypad!

Currently, the Model 3440 gauge topshell is manufactured from an engineering thermoplastic designed specifically to provide high impact strength and to offer excellent compatibility with many industrial solvents and petrochemicals. The topshell may be cleaned with mild (low alkaline) soap and water. Other approved cleaning substances include methyl, isopropyl, or isobutyl alcohols.

 **CAUTION**

The use of any unapproved cleaning agents such as methyl-ethyl-ketones, amines, and methylene chloride will damage the topshell and void the warranty.

## Source Rod Lubrication

If the source rod does not slide up and down freely, the source rod bearing may require cleaning and lubrication.

1. Remove the control panel assembly from the gauge by loosening the four captive screws that secure it to the topshell. Lift the control unit and disconnect the ribbon cable. Set control unit aside.
2. Locate the grease fitting at the base of the source rod tower.

### NOTE

The vent valve was not installed on earlier gauges. Instead, an Allen-head screw was located beneath the grease fitting. On the gauges, remove the Allen-head screw before applying lubricant to allow the old grease to be ejected. Failure to remove the Allen screw may result in severe mechanical damage to the base assembly.

3. Using a standard 16-ounce grease gun loaded with a Magnalube-G cartridge, apply five shots of lubricant or enough to eject all dirty grease until clean grease is visible.
4. Re-assemble the gauge. Do not apply more than 6 in-lb. torque to the topshell screws.

## Lubricating the Source Rod

If the source rod does not slide up and down freely, the source rod bearing may require lubrication. A grease fitting is located beneath the top shell at the base of the source rod tower.

1. Remove the control unit from the gauge by loosening the four captive screws that secure the control unit to the top shell. Lift the control unit out of the gauge and disconnect the ribbon cable.
2. Locate the grease fitting at the bottom of the source rod tower.
3. Using a standard 16-oz grease gun loaded with a Magnalube®-G cartridge, apply five shots of lubricant to the grease fitting.
4. Re-assemble the control unit.

## Gasket Replacement

Four gaskets seal the gauge from moisture, dirt, and debris. Condensation may form inside the gauge if the gauge has been out in extremely wet weather or in high humidity, or if it is used in the heat and stored in an air conditioned building. In this case, remove the topshell and allow the gauge to dry. If necessary, use a hairdryer (on low heat) to remove any built-up moisture. If moisture continues to be a problem or debris is present inside the gauge base, the gaskets may need replacing.

To replace the control panel gasket (P/N 110841), loosen the four screws in the corners of the panel, and remove the panel from the gauge topshell. Use care in removing the panel and disconnecting the ribbon cable. Gently peel the old gasket from the panel and replace with a new gasket. Reconnect the ribbon cable and replace the control panel.



To replace the two post gaskets and the topshell gasket, remove the screws that hold the topshell to the gauge base. Remove the screws from the metal triangle around the base of the triangle extrusion and raise this piece. Then lift the topshell from the base. Gently peel the gaskets away from the topshell and gauge base and replace. Tighten topshell screws to 6 in-lb.

If replacing the post gaskets, slide up and over the source rod handle. A light coating of talcum powder on the inside of the new post gasket will aid in reassembly.

## Replacing Gasket and O-Ring

The gauge uses a gasket and O-rings to protect its electronics from moisture, dirt, and debris. However, if the gauge has been exposed to extremely wet weather or high humidity, or if the gauge was used in the cold and stored in a warm building, condensation may form inside the gauge.

If this happens, remove the control unit to allow the gauge to dry. Use a hair dryer (on low heat) if necessary to remove any built-up moisture. If moisture continues to be a problem or debris is present inside the gauge base, the control panel gasket or top shell O-ring may need replacing.

To replace the control panel gasket (P/N 110841), loosen the four captive screws that attach the control unit (keypad) to the top shell. Carefully lift the control unit from the top shell and detach the ribbon cable. **Gently** peel the old gasket from the panel and replace it with a new gasket. Reconnect the ribbon cable and reinstall the control unit.

To replace the top shell O-ring (P/N 110899), remove the six screws that hold the top shell to the gauge base. Lift the top shell from the gauge base to expose the O-ring. Peel the old O-ring from the groove in the gauge base. Place the replacement O-ring in the groove, and run your finger around its circumference to ensure it is properly seated in the groove. If the O-ring is too long, cut it to length, ensuring that the two ends butt against each other. Reassemble the top shell to the base.

# Replacement Parts

---

This section provides a list for replacing the major parts of the gauge and purchasing accessories. Many parts can be ordered from our e-commerce site at [www.troxlerlabs.com](http://www.troxlerlabs.com).

PART NO.	DESCRIPTION
110821	3440 Gauge Topshell O-ring/Gasket
110013	3440 Bottomplate
110016	3440 Battery Assembly (with case)
110821	3440 Topshell
110848.0040	3440 Nameplate
007158	O-ring for Triangle Tower

## Maintenance Supplies

PART NO.	DESCRIPTION
012784	Lubricant, Magnalube-G paste 1.5 oz. tube
012786	Lubricant, Magnalube-G paste 1 lb. can
012789	Lubricant, Magnalube-G 14.5 oz.
100761	Source rod pig
018141	BindOff (1 gallon)

## Accessories

PART NO.	DESCRIPTION
110017	3440P/3440 Shipping Case
100421	Drill Rod
102111	Scraper Plate

103680.1000	Extraction Tool
110403	AC Adapter, 12 V CE
110867	AC Adapter, International, 6 pc
104156	DC Charger
110991	3440 Operator's Manual
113128	RS-232 Cable
102876.0005	Leak Test Kit (4 units)
109661	TroxAlert Survey Meter
104661.4000	Printer Package
107480	Concrete Adapter
021140	Radiation Sign Kit
109661	TroxAlert Survey Meter with beeper
105817	Emergency Response Kit
104661.4000	Printer Package

## Returning the Gauge for Service

---

All shipments within the United States to the factory must be accompanied by an RGA (Returned Goods Authorization) number, and a description of the instrument and its problem. Send a completed [RGA form](#), found on the Downloads page at [www.troxlerlabs.com](http://www.troxlerlabs.com), with each item returned for service. This information is used by Troxler shipping and service personnel to expedite the repair work.

To obtain an RGA number, please call or fax the factory or branch office with your request. Please have the following information available when contacting Troxler for an RGA number:

- ◆ Is the gauge still under warranty?
- ◆ Model and Serial number
- ◆ Will estimate be required before performing any work on the gauge?
- ◆ Problem or difficulty you are having with the instrument.
- ◆ Shipment method to Troxler and for return shipment.
- ◆ Shipping and billing address (not P.O. Box): street address and zip code.
- ◆ Telephone number and contact (for questions from Troxler).
- ◆ Payment method: credit card, account number, or purchase order number. All U.S. government agencies (city, county, state and federal) must send purchase orders.

# NOTES



# Appendix B: Specifications

---

This appendix provides the measurement specifications for Model 3440 gauges.

# Measurement Specifications

---

## Density at 2000 kg/m<sup>3</sup>

### Direct Transmission (150 mm)

	.25 min	1 min	4 min
Precision (kg/m <sup>3</sup> )	±6.8	±3.40	±1.70
Composition error (kg/m <sup>3</sup> )	±20.0	±20.0	±20.0
Surface error (kg/m <sup>3</sup> ) (100% Void)	-17.0	-17.0	-17.0

### Backscatter (98%, 100 mm)

	.25 min	1 min	4 min
Precision (kg/m <sup>3</sup> )	±16.0	±8.00	±4.00
Composition error (kg/m <sup>3</sup> )	±40.0	±40.0	±40.0
Surface error (kg/m <sup>3</sup> ) (100% Void)	-75.0	-75.0	-75.0

## Moisture at 240 kg/m<sup>3</sup>

	.25 min	1 min	4 min
Precision (kg/m <sup>3</sup> )	±10.3	±5.1	±2.6
Surface error (kg/m <sup>3</sup> ) (1.25 mm, 100% void, kg/m <sup>3</sup> )	-18.0	-18.0	-18.0

Precision is defined as ±one (1) standard deviation in density readings. This number is calculated by the ratio of the standard deviation in the counting rate and the slope of the calibration curve at a given density.



# U.S. Customary Units

## Density at 125 PCF

### **Direct Transmission (6 inches)**

	<b>.25 min</b>	<b>1 min</b>	<b>4 min</b>
Precision (pcf)	±0.42	±0.21	±0.11
Composition error (pcf)	±1.25	±1.25	±1.25
Surface error (pcf) (100% Void)	-1.06	-1.06	-1.06

### **Backscatter (98%, 4 inches)**

	<b>.25 min</b>	<b>1 min</b>	<b>4 min</b>
Precision (pcf)	±1.00	±0.50	±0.25
Composition error (pcf)	±2.50	±2.50	±2.50
Surface error (pcf) (100% Void)	-4.68	-4.68	-4.68

## Moisture at 15 PCF

	<b>.25 min</b>	<b>1 min</b>	<b>4 min</b>
Precision (pcf)	±0.64	±0.32	±0.16
Surface error (pcf) (0.05 in., 100% void, pcf)	-1.12	-1.12	-1.12

# Radiological Specifications

---

<b>Gamma Source</b>	0.30 GBq (8 mCi) $\pm$ 10% Cs-137
<b>Neutron Source</b>	1.48 GBq (40 mCi) $\pm$ 10% Am-241:Be
<b>Source Type</b>	Sealed Source – Special Form
<b>Source Housing</b>	Stainless Steel, Encapsulated
<b>Shielding</b>	Lead, Tungsten
<b>Surface Dose Rate</b>	See Radiation Profile on page D-17
<b>Shipping Case</b>	Type A, Yellow II, TI = 0.3

# Electrical Specifications

---

**Stored Power** 4 ampere hours

**Average Current Consumption**

<b>Normal</b>	35 mA
<b>With backlight on</b>	140 mA
<b>With GPS on</b>	105 mA
<b>With backlight and GPS on</b>	210 mA

Time Before Automatic Shutdown 5 hours of complete inactivity

Power Source(s):

**Main** 5 C NiMH (Rechargeable)

<b>Backup (optional)</b>	Pack) batteries 5 AA alkaline batteries
<b>Charge Source</b>	12 V dc, 2A
<b>Battery Recharge Time</b>	3 hours maximum, automatic cutoff (may be charged incrementally without damaging the batteries)
<b>Liquid Crystal Display</b>	Alphanumeric, 4 line × 20 character, backlit
<b>Keypad</b>	30-key sealed membrane
<b>Serial Data Format</b>	9600 baud 1 stop bit No parity 8 data bits Xon-Xoff flow control

**Gauge-to-PC Computer Cable  
(Null Modem Serial Cable, P/N 113128)**

<u>9 pin FEMALE</u>	<u>9 pin FEMALE</u>
Rx (pin 2)	Tx (pin 3)
Tx (pin 3)	Rx (pin 2)
Gnd (pin 5)	Gnd (pin 5)

<b>USB Port (optional)</b>	A list of compatible USB devices is available at <a href="http://www.troxlerlabs.com/documents">www.troxlerlabs.com/docume nts</a>
----------------------------	--

# Mechanical Specifications

---

**Gauge Size (w/ handle)**

**12-Inch Rod** 597 H × 368 L × 229 W mm  
(23.5 H × 14.5 L × 9 W in.)

**8-Inch Rod** 495 H × 368 L × 229 W mm  
(19.5 H × 14.5 L × 9 W in.)

**Shipping Case Size**

745 H × 419 L × 353 W mm  
(29.35 H × 16.5 L × 13.88 W in.)

**Weight**

14.1 kg (31 lb.)

**Shipping Weight**

37.6 kg (83.0 lb.)

**Operating Temperature**

0 to 70 °C  
32 to 158 °F

**Max Test Material Surface**

175 °C (347 °F) for 15 minutes

**Storage Temperature**

-55 to 85 °C  
-67 to 185 °F

**Humidity**

98% RH, non-condensing

**USB Port**

Accepts devices up to  
10 H x 29 W mm  
(0.40 H x .79 W in.)



**CAUTION**

This instrument contains sensitive electronic and nuclear components. This instrument *must not* be subjected to stress, abuse, or use other than in accordance with the standard operating procedures listed in this manual.

# Appendix C: Transporting & Shipping

---

Devices containing radioactive materials must be transported in accordance with the rules of the U.S. Department of Transportation (DOT) and the International Atomic Energy Agency (IAEA).

The IAEA recommendations have been codified in the International Air Transport Association (IATA) Dangerous Goods Regulations. International customers should consult their local government or licensing authority for applicable regulations.

# U.S. Shipping Requirements

---

The U.S. DOT hazmat regulations (49 CFR, Parts 100–185) apply any time a nuclear device is transported by motor vehicle on a public highway or by other means of transport (rail, air, ship).

The major requirements for transporting a nuclear gauge in the United States are listed below. For more detailed information about these requirements, please refer to the *Troxler Transportation Guide*.

- ◆ A copy of the current IAEA Certificate of Competent Authority for each source in the gauge (Special Form Certificate) must be kept on file. Current versions can be downloaded from the Troxler website, [www.troxlerlabs.com](http://www.troxlerlabs.com).
- ◆ A copy of the results of the Type A package testing must be kept on file.
- ◆ Hazmat employee training records must be kept on file.
- ◆ An *Emergency Response Information* document must be in the vehicle and immediately accessible to the driver.
- ◆ A properly completed bill of lading must be in the vehicle and immediately accessible to the driver. The shipping papers must include a 24-hr emergency response phone number.
- ◆ If shipping by air, a *Shipper's Declaration for Dangerous Goods* must accompany the air waybill.
- ◆ The package must be properly marked and labeled in accordance with hazmat regulations.
- ◆ The package must have a tamper-evident seal.
- ◆ The package must be inspected prior to each shipment.
- ◆ The package must be securely blocked and braced in the vehicle to prevent shifting during transport.

## **Accident Notification Requirements**

In the event of a reportable incident involving radioactive material, notify the licensing agency as soon as practical. The operator is also required to notify, at the earliest practical moment, the U.S. DOT at 1-800-424-8802 of an accident that occurs during the course of transportation (including loading, unloading, and temporary storage) in which fire, breakage, spillage, or suspected contamination occurs involving shipment of radioactive materials.

## **Hazmat Training**

The U.S. DOT regulations require every hazmat employer to train, test, certify, and maintain records for each hazmat employee. Hazmat training applies to anyone who transports or prepares for transport radioactive materials. Refresher training is required every three years for shipment / transport by roadway in the US. Shipment by air requires training every 2 years under IATA Dangerous Goods regulations.

# Canadian Shipping Requirements

---

The *Transportation of Dangerous Goods Act and Regulations* (TDG) and *Transport Packaging of Radioactive Materials Regulations* (TPRM) apply any time a nuclear device used in commerce is transported by any means in Canada.

For training and accident notification requirements, consult the *Transportation of Dangerous Goods Regulations*. For further information on transporting a nuclear device, contact the transportation section of the Canadian Nuclear Safety Commission (CNSC).



# Appendix D: Radiation Theory & Safety

---

This appendix is required reading for anyone who will operate the Model 3440 Surface Moisture-Density Gauges.

This appendix covers topics related to radiation theory and the safe operation of the gauge. A brief overview of the regulatory requirements related to the ownership and use of the gauge, as well as a listing of radiation safety-related warnings and cautions, is included.

# Radiation Theory

---

A more detailed discussion of radiological theory can be found in the *Troxler Nuclear Gauge Safety Training Program* manual, provided at the Troxler Safety Class.

## Atomic Structure

All matter is made up of atoms. For example, water has two atoms of hydrogen (H) and one atom of oxygen (O), which in chemical notation is written  $H_2O$ .

An atom is made up of a dense nucleus, consisting of positively charged protons and uncharged neutrons, surrounded by a cloud of negatively charged electrons. Under normal circumstances, the number of electrons in an atom equals the number of protons. The number of protons in the atom is called the *atomic number* ( $Z$ ). A chemical element consists of all atoms having the same atomic number.

The number of protons plus neutrons in the nucleus is called the *atomic mass* ( $A$ ). Atoms of a given chemical element can exist in slightly different variants called *isotopes* that have different atomic masses. For example, carbon-12 (C-12) is non-radioactive and carbon-14 (C-14) is radioactive. Isotopes that are radioactive are termed radioisotopes or radionuclides.

Figure 14 depicts a helium atom consisting of two protons and two neutrons in the nucleus and two orbiting electrons.

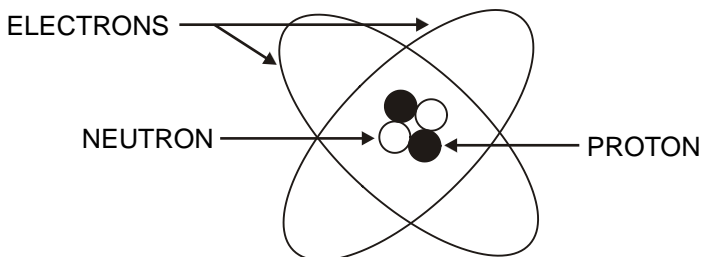

Figure 14. Diagram of an Atom

# Radioactivity

Radioactivity is the spontaneous transformation (or disintegration) of an unstable nucleus into a more stable configuration accompanied by the emission of radiation.

The quantity of a radioactive material is measured in terms of the average number of nuclear disintegrations per unit time. The traditional unit of measure for radioactivity (or *activity*) is the *curie* (Ci), which is defined as  $3.7 \times 10^{10}$  disintegrations per second. The activities of the radioactive sources in nuclear gauges are so small that they are typically measured in *millicuries* (mCi), which is one-thousandth of a curie, or *microcuries* ( $\mu$ Ci), which is one-millionth of a curie.

In the Standard International (SI) (or *metric*) system, the unit of activity is the *becquerel* (Bq), which equals one disintegration per second. Because the becquerel is such an extremely small unit, the activity of sources in nuclear gauges is normally expressed in *megabecquerel* (MBq), which is one million becquerels, or *gigabecquerel* (GBq), which is one billion Bq.

The radioactivity of a source is not constant, but decreases with time as the source decays. The time it takes for one-half of the original atoms to disintegrate is called the *half-life*. In successive half-lives, the activity decreases to 1/2, 1/4, 1/8 and so on of the initial value. After seven half-lives, less than 1% of the original radioactive atoms remain. Each radioisotope has a characteristic half-life, which can range from seconds to billions of years. The half-lives for the typical radioisotopes used in nuclear gauges are:

Radioisotope	Half-life
Cs-137	30 years
Am-241	432 years

# Types of Radiation

The radioactive sources in the gauge produce four types of radiation:

Alpha particles

Beta particles

Gamma rays (photons)

Neutrons

The alpha and beta particles are stopped by the source capsule. Therefore, they present no external hazard to personnel. Only the gamma and neutron radiation from sealed sources contribute to any occupational radiation exposure.

Gamma rays (photons) are a type of electromagnetic radiation, like X rays, radio waves, and visible light. Photons have no mass or electrical charge, and travel at the speed of light. Gamma rays are energetic and penetrating. Dense materials (such as lead, tungsten, and so on) provide the best shielding against gamma radiation.

Neutrons are a form of particulate radiation but, unlike alpha and beta particles, they have no electrical charge. This makes neutron radiation very penetrating. Fast neutrons lose energy primarily by so-called “billiard ball” elastic collisions with the nuclei of low atomic number atoms, especially hydrogen. The best shielding materials for fast neutrons are those with a high hydrogen content, such as water, concrete, and polyethylene.

# Radiation Safety

---

This section discusses the principles of general radiation safety. This information includes specific procedures for operating, inspecting, cleaning, and leak testing the gauge to ensure safe operation.

## Radiation Dose

Radiation cannot be detected by any of the human senses (sight, touch, hearing, smell). However, using appropriate instruments and devices, radiation can be detected and measured at levels far below those that significantly affect health.

For purposes of radiation protection, the basic unit of radiation dose is the *rem*. The SI unit is the *sievert (Sv)*, where 1 Sv = 100 rem. The rem is a relatively large unit, so often radiation dose is expressed in smaller units called millirem (mrem), where 1 rem = 1000 mrem.

The risk of injury from radiation is generally related to the total radiation dose received over a period of time. It is also related to the dose rate, which is the amount of dose received per unit time. The same amount of radiation received over a long period (months to years) is much less hazardous than if received over a very short period (hours). This has to do with the body's ability to repair cell damage caused by the radiation.

The U.S. Nuclear Regulatory Commission (NRC) has established the following limits on the amount of whole body radiation exposure that individuals may safely receive from licensed radioactive materials.

Type of Individual	Dose Limit
Adult worker	5000 mrem per year
Minor (under 18 years old)	500 mrem per year
Member of the public	100 mrem per year

## Limiting Exposure

Under average conditions, an individual working with the gauge will receive less than 200 mrem per year.

A basic principle of radiation protection is that radiation exposure should be kept as far below the limits as is reasonably achievable. This is known as the *ALARA* (as low as reasonable achievable) principle. The three methods for limiting exposure are:

- ◆ Time
- ◆ Distance
- ◆ Shielding

### Time

The simplest way to reduce exposure is to minimize the time spent around a radioactive source. If the time spent near a source is cut in half, then the exposure is halved, all other factors remaining constant.

### Distance

Distance is another effective means to reduce radiation exposure. A formula known as the *inverse square law* relates the radiation exposure rate to distance (see Figure 15). Doubling the distance from a radiation source reduces the exposure to one-fourth its original value. If the distance is tripled, then the exposure is reduced by a factor of nine, and so on.

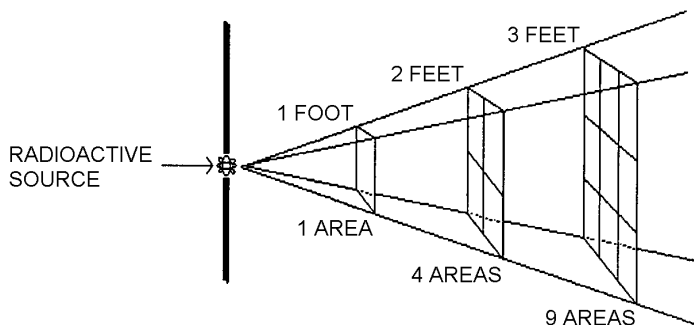

Figure 15. Effect of Distance on Exposure

## Shielding

Shielding is any material used to reduce the radiation exposure rate from a radioactive source. The gauge has some built-in shielding, which reduces the exposure rate. When gauges are in storage, additional shielding may be necessary to keep exposure to personnel in adjacent areas below the dose limits for members of the public.

The thickness of any material that reduces the incident radiation intensity by one-half is known as the *half-value layer (HVL)*. The HVL of a material varies with the type and energy of radiation. The HVL values of certain common shielding materials are shown below for gamma and fast neutron radiation.

Material	Cs-137 Gamma Half-Value Layer	Am-241:Be Neutrons Half-Value Layer
Concrete	1.9 in.	4.3 in.
Lead	0.3 in.	†

## Personnel Monitoring

In the United States, anyone working with or near radioactive materials is subject to occupational dose limits. Individual monitoring of each authorized user is recommended in order to demonstrate compliance with these dose limits.

The most common types of individual monitoring devices used by licensees are film badges and thermoluminescent dosimeter (TLD) badges. Film badges are typically exchanged and processed monthly due to concerns about film fading. TLD badges are usually exchanged quarterly. Troxler offers NVLAP-certified personnel monitoring services using TLD badges.

In Canada, nuclear gauge users are not normally classified as Atomic Radiation Workers. In such cases, the general public

---

† Lead does not provide any effective shielding of fast neutrons.

dose limit of 500 mrem/year applies. Users may not be required to wear a dosimeter. To establish the personnel monitoring requirements for your application, consult the conditions of your radioisotope license and the CNSC regulatory document *R91: Monitoring and Dose Recording for the Individual*.

## Source Encapsulation

The neutron (americium-241:beryllium in the Model 3440 and photon (cesium-137) source materials are welded inside stainless steel capsules. These sealed sources meet U.S. and international regulatory requirements for classification as “Special Form” radioactive material for purposes of transportation. The sealed sources are designed to prevent leakage of radioactive material under severe accident conditions. They are also designed to comply with applicable ANSI classification requirements for sealed sources used in portable gauges.

## Source Rod Inspection

To ensure the integrity of the source rod, Troxler recommends that a qualified Troxler service person inspect the gauge and the source rod at least once every five years. This inspection includes checking for excessive wear, corrosion, or damage that could affect the safety of gauge operation.

However, as a precaution if the gauge is ever damaged or dropped, ensure that the tip of the source rod is intact and undamaged (that is, ensure that the source is not missing) as described on page D-9.

Contact the Troxler Radiation Safety Department for further advice.



## Daily Inspection

The gauge should be inspected daily before use to ensure proper operation of all safety features as follows:

- ◆ The source rod opening in the bottom of the gauge is equipped with a spring-loaded tungsten sliding block that shuts when the source rod is in the **SAFE** (shielded) position. To check the operation of the sliding block, push the source rod down into the backscatter position (see Figure on page 3–5), and then raise it back to the **SAFE** position. You should hear a *click* as the sliding block snaps shut. Turn the gauge over and verify that the sliding block is completely shut. If any portion of the opening is uncovered, the sliding block should be cleaned before using, transporting, or storing the gauge. Refer to page D–10 for instructions on cleaning the tungsten sliding block.



### WARNING

**Do not store or transport the gauge unless the sliding block is closed. Increased radiation levels may cause excessive personnel radiation exposure and may violate transportation regulations.**

If a radiation survey instrument is available, verify that the radioactive gamma source is in place by measuring the exposure rate at the surface of the gauge. The exposure rate should be approximately 10 – 20 mrem per hour. A reading of about 1 mrem or less indicates either that the survey instrument is not working properly or that the cesium-137 source may be missing. Refer to the *Troubleshooting* section of Appendix A for further instructions.

## Cleaning the Tungsten Sliding Block

If the tungsten sliding block is not kept clean, it may stick partially or completely open when the source rod is raised to the **SAFE** (shielded) position.

This will result in high radiation levels near or in line with the source rod opening on the bottom of the gauge. After cleaning and reassembling the gauge as described below, check the operation of the sliding block by pushing the source rod into the backscatter position, then returning it to the **SAFE** position. You should hear a *click* as the sliding block snaps shut.

Inspect the opening on the base of the gauge to confirm that the sliding block is closed. If not, check that the sliding block spring was properly installed after cleaning. If the sliding block still does not close properly, immediately contact the nearest Troxler Service Center. For a list of Troxler and authorized Troxler service centers, refer to the front of this manual or visit the Troxler website AT: [www.troxlerlabs.com/services](http://www.troxlerlabs.com/services)

The tungsten sliding block may require cleaning if the source rod becomes difficult to lower into the “measure” position, or if a *click* is not heard when the source rod is raised to the **SAFE** (shielded) position. An improperly operating sliding block may also result in erratic or incorrect density readings and increased radiation levels.



### WARNING

Removal of the sliding block results in dose rates of up to one rem per hour in the path of the beam. Stand clear of the gauge bottom while performing this procedure and proceed as quickly as possible while working in the cavity to minimize exposure to your extremities.

1. With the source rod in the **SAFE** (shielded) position, place the gauge on its side.
2. Clean the heads of the four corner screws that hold the bottom plate to the gauge base (see Figure 16). Using a

Phillips screwdriver, remove the four screws in the corner of the plate and remove the plate.

3. To reduce radiological exposure, stand to one side of the gauge. Paying close attention to the position of the sliding block, remove the block.
4. Using a stiff brush or rag soaked in alcohol, clean the sliding block and the cavity.
5. Re-install the sliding block with the angled side up. Apply a light coating of Magnalube-G paste to the **top angled** surface of the sliding block.
6. Re-install the bottom plate. Do not over-tighten screws! Ensure that the source rod moves up and down freely.

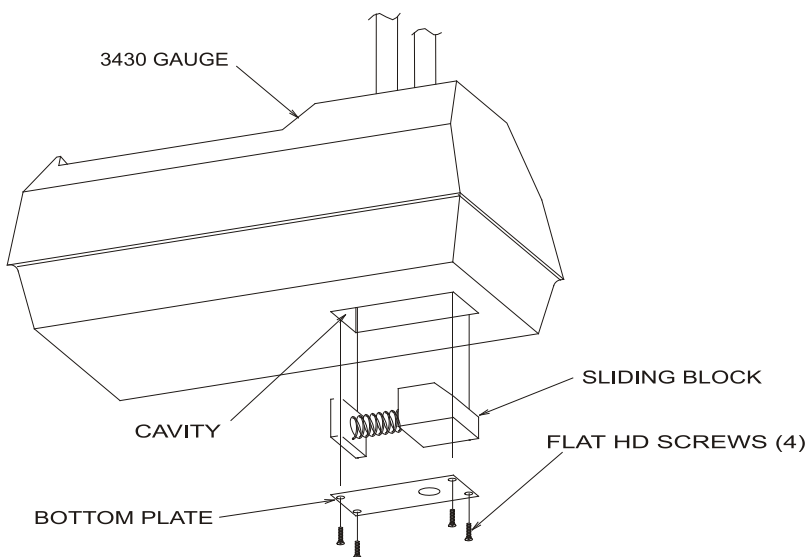
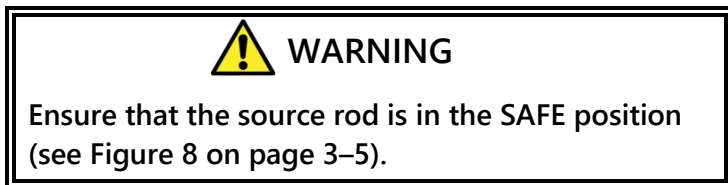

Figure 16. Cleaning the Tungsten Sliding Block

## Leak Testing

***Unless specified otherwise by your license or state regulations,*** the gauge must be leak tested at intervals not exceeding 12 months to ensure the integrity of the radioactive source encapsulation. Sample analysis must be performed by a licensed laboratory only.

Using the Troxler Model 3880 Leak Test Kit (PN 102868) and accompanying instructions, perform the following procedure:



1. Write the date, gauge model number, and serial number on the sample form and label.
2. Remove the control panel from the gauge topshell. Locate the yellow radiation label on the top surface of the base.
3. Holding the wipe disk with the tongs, wipe the radiation label.
4. Turn the gauge on its side and locate the opening where the source rod extends through the gauge base.
5. Holding the wipe disk with tongs, wipe the area around and inside the opening where the source rod extends from the gauge base.
6. Pack the disk, as instructed, in the envelope and mail to Troxler Electronic Laboratories, Inc. for analysis.
7. Secure the gauge properly.

# Regulatory Requirements

---

This section summarizes the licensing and training requirements that pertain to ownership or operation of a nuclear gauge. This section also provides information on the proper disposal of the gauge, as well as emergency procedures to follow if the gauge is lost, stolen, or damaged.

## Licensing

In the United States, possession and use of the radioactive materials in a nuclear gauge require a license issued by the U.S. Nuclear Regulatory Commission (NRC) or an Agreement State licensing agency. Detailed information on obtaining a license is contained in the *Troxler Licensing Guide*. Copies of this guide are available from Troxler, or can be downloaded from the Troxler website: [www.troxlerlabs.com](http://www.troxlerlabs.com).

To purchase a nuclear gauge in Canada, an owner must obtain a radioisotope license from the Canadian Nuclear Safety Commission (CNSC). The owner should obtain copies of the CNSC Regulations and the Transportation of Dangerous Goods Act and Regulations. For other countries, please consult your local regulatory agency.

## Training

In the United States, anyone working with or near radioactive materials must complete a radiation safety training course to be designated an *authorized user*. Authorized users must be trained in the precautions and procedures to minimize radiation exposure; applicable regulatory requirements; and the operating, emergency, maintenance, and transportation procedures for the gauge. Troxler offers training classes designed to meet regulatory agency training requirements for nuclear gauge users.

# Disposal

A nuclear gauge contains licensed radioactive material. At the end of a gauge's service life, it must not be discarded as ordinary trash, recycled as scrap material, or abandoned. Instead, a nuclear gauge must be transferred to an authorized recipient licensed by the NRC or an Agreement State. For further information on gauge disposal, contact Troxler.

# Emergency Procedures

If the nuclear gauge is lost or stolen, then immediately notify the gauge owner's Radiation Safety Officer (RSO).

The gauge owner should complete the emergency contact information on the lines furnished below. (Note that company refers to the gauge owner's company, not Troxler Electronic Laboratories.) This information should be readily available to the gauge operator at all times.

The company RSO is _____
Call the RSO at _____
The regulatory agency is _____
Call the agency at _____

If a gauge is damaged, then follow the steps below:

1. Locate the gauge and/or sources.
2. Do not touch or move the gauge.
3. Immediately rope off an area around the nuclear gauge and/or sources. A radius of 15 ft. (5 m) is sufficient. Do not leave the area unattended.
4. Keep all unauthorized personnel from the nuclear gauge.
5. If a vehicle is involved, it must be stopped until the extent of contamination, if any, can be established.



6. The gauge user should perform a visual inspection of the nuclear gauge to determine if the source housing or shielding has been damaged.
7. Use a survey meter (such as the TroxAlert Survey Meter) to measure the dose rate at a distance of 1 m (3 ft.) from the gauge.
8. Contact the company RSO (name and number given at the beginning of this section). Provide the RSO with the following:
  - a. The date, time, and location of the accident
  - b. The gauge model and serial number
  - c. The nature of the accident
  - d. The location and condition of the gauge and/or source
  - e. The dose rate at 1 m (3 ft.) from the gauge
9. If you are unable to reach the RSO, then call your regulatory agency (name and number given at the beginning of this section).
10. Follow the instructions of the RSO. The RSO may need to report the incident to the regulatory agency. The RSO may also be required to notify the USDOT of accidents during transport.
11. Before shipping a damaged gauge to Troxler, obtain an RGA (Returned Goods Authorization) number from the Troxler Customer Service Department, as described in the *Returning the Gauge for Service* section on page A-22.

# Gauge Use Precautions

---

The following precautions should be observed when transporting, storing, maintaining, or operating the gauge.

- ◆ Never touch the unshielded tip of the source rod with your bare hands. The dose rates on contact with the source rod tip can result in exposures exceeding the annual dose limits to the skin of the extremities within a short time period (about 1 hour).
- ◆ When not taking readings, always keep the source rod in the **SAFE** (shielded) position. For added user safety, the source rod automatically retracts to the **SAFE** position when the gauge is lifted by the handle.
- ◆ If you do not hear a *click* when the gauge is raised to the **SAFE** position, look at the bottom of the gauge to verify that the tungsten sliding block is completely closed. If the gauge base opening is not completely closed by the sliding block, the sliding block may require cleaning. Refer to page D-10 for cleaning instructions.
- ◆ Do not store or transport the gauge unless the sliding block is completely closed. Increased radiation levels may cause excessive personnel radiation exposure and may violate transportation regulations.
- ◆ When preparing a test site, use the drill rod assembly to drill the test hole. Under no circumstances should the source rod of the gauge be used to drill holes.
- ◆ Do not tamper with or modify the gauge. Also, do not remove the sealed source from the gauge. Tampering with or modifying the gauge or removing the sealed source can be dangerous. Such actions are illegal unless authorized by your radioactive materials license.



# Radiation Profile

---

Table 5 shows the radiation profile for the Model 3440 gauge. Each table lists the radiation dose equivalent rates (in mrem/hour) for each side of the gauge and transport case shown in Figure 17.

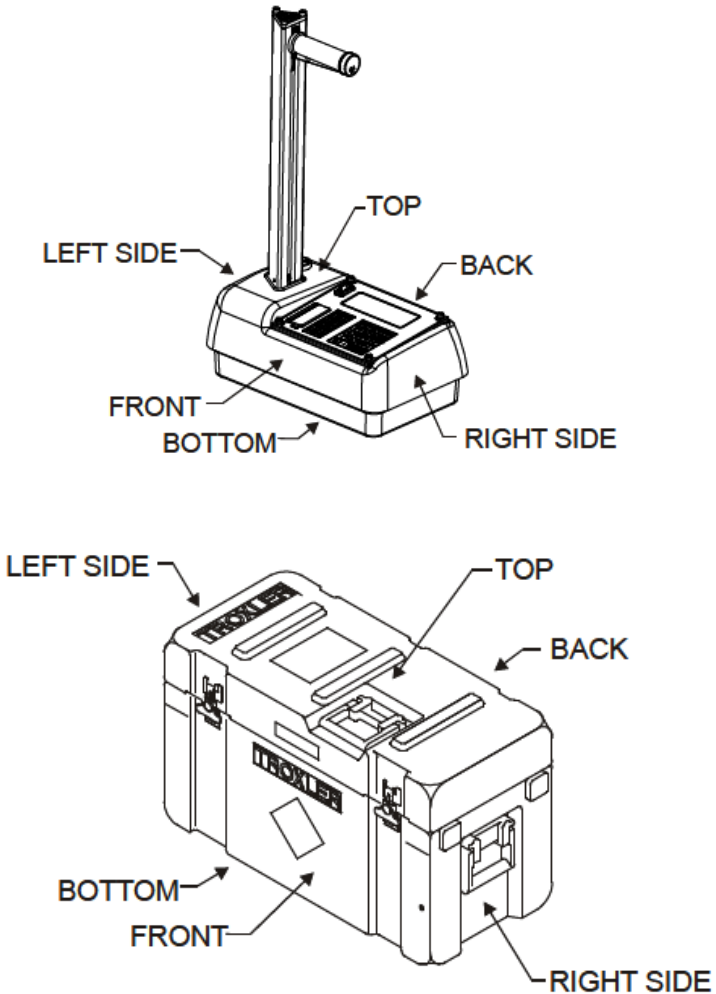

Figure 17. Model 3440 Gauge and Transport Case

Table 5. Radiation Profile for Model 3440 Gauge

(Exposure rate in mrem/hour)

	Surface		5 cm		30 cm		100 cm	
	Gamma	Neutron	Gamma	Neutron	Gamma	Neutron	Gamma	Neutron
<b>GAUGE</b>								
<b>Top</b>	30.0	1.0	20.0	1.0	2.0	0.2	§	§
<b>Bottom</b>	19.0	3.0	9.0	2.0	0.6	0.6	§	§
<b>Left Side</b>	25.0	0.6	10.0	0.4	1.2	0.2	0.2	§
<b>Right Side</b>	8.0	1.2	3.0	0.4	1.0	0.2	0.2	§
<b>Front</b>	16.0	1.0	9.0	0.6	1.7	0.2	0.3	§
<b>Back</b>	25.0	1.0	13.0	0.8	2.0	0.3	0.4	§
<b>GAUGE IN TRANSPORT CASE</b>								
<b>Top</b>	17.0	0.2	8.0	0.2	1.2	§	0.2	§
<b>Bottom</b>	6.0	0.2	4.0	0.2	1.0	0.2	0.4	§
<b>Left Side</b>	1.0	§	0.8	§	0.3	§	§	§
<b>Right Side</b>	9.0	2.0	4.0	1.6	0.5	1.0	§	§
<b>Front</b>	9.0	0.4	6.5	0.2	2.0	§	0.2	§
<b>Back</b>	7.0	0.2	5.0	0.2	2.0	§	0.2	§

NOTES:

1. Radiation measurements were of a gauge containing a nominal 8 millicuries Cesium-137 gamma source and a nominal 40 millicuries Americium-241: Beryllium neutron source.
2. Gamma measurements were taken with a Bicron Micro Rem survey meter, Serial Number B464Y calibrated in January 2011.
3. Neutron measurements were taken with a Ludlum Model 12-4 survey meter, Serial Number 140077 calibrated in September 2011.
4. The symbol § denotes a radiation measurement of less than 0.2 millirem per hour.
5. Measurement position nomenclature for the gauge and transport case is shown in Figures 1 and 2.
6. Orientation of the gauge in the transport case is as follows:
  - a. Back of the gauge to the front of the case
  - b. Bottom of the gauge to the right side of the case, and
  - c. Top of the gauge to the left side of the case.

# NOTES

# Appendix E:

# Unit Conversion

---

This chapter contains the following topics and tasks:

- ✓ Measurement units
- ✓ Radiological units

The Model 3440 gauges can display measurement results in either SI (metric) units or English units. Also, HM-181 of 49 CFR changes the standard units of radioactivity in the United States from the English unit of *curies (Ci)* to the SI unit of *becquerel (Bq)*. This requires the shipper to convert the activity on the Bill of Lading from curies to becquerels (GBq). Until everyone is accustomed to the SI units, it is permitted to follow the SI units with the English units in parentheses to clarify the description [for example: 1.48 GBq (40 mCi)].

To help you convert from English units to SI units, the following provides SI conversion factors for common English units relevant to the gauge.

## Measurement Units

---

1 in. = 25.4 mm	1 ft. = 30.48 cm	1 pcf = 16.02 kg/m <sup>3</sup>
1 in. = 2.54 cm	1 ft. = 0.3048 m	1 pcf = 1.6 × 10 <sup>-2</sup> g/cm <sup>3</sup>

## Radiological Units

---

$$1 \text{ rem} = 0.01 \text{ Sv}$$

$$1 \text{ Ci} = 37 \text{ GBq}$$

$$1 \text{ mCi} = 37 \text{ MBq}$$

$$1 \text{ } \mu\text{Ci} = 37 \text{ kBq}$$

The following table is provided to assist in converting from millicuries to gigabecquerels:

mCi to GBq	
8.0	0.30
40	1.48

# Appendix F: Standard Count Log

---

Use the form in this appendix as a guide when recording the daily standard counts. To verify gauge stability, compare the daily standard count to the average of the last four recorded standard counts.





# Appendix G: Special European Considerations

---

This appendix covers the following topics:

- ✓ Declaration of Conformity
- ✓ Safety Warnings

This section applies only to those Troxler Model 3440 Surface Moisture-Density Gauges with the CE mark that are to be used in European countries.

# Declaration of Conformity

---

Application of Council EMC Directive 89/336/EEC.

## NOTE

The Low Voltage Directive 73/23/EEC does not apply to the Model 3440 Surface Moisture-Density Gauges because there are no voltages greater than 75 V dc that are accessible by the operator.

### Standards to Which Conformity is Declared:

#### *Guidance Documents:*

Emissions: EN 61326-2:2006

Immunity: EN 61326-2:2006

#### *Test Methods:*

Emissions: EN 55011:1997 + A1:1999 + A2:2002,  
EN 61000-3-2:2006 + A1:2009 + A2:2009  
EN 61000-3-3:1995 + A1:2001

Immunity: EN 61000-4-2:1995 + A1:1998 + A2:2001,  
EN 61000-4-3:2002, EN 61000-4-4:2004,  
EN 61000-4-5:1995 + A1:2001,  
EN 61000-4-6:1996 + A1:2001,  
EN 61000-4-8:1993 + A1:2001,  
EN 61000-4-11:2004

**Manufacturer:** Troxler Electronic Laboratories, Inc.  
P.O. Box 12057  
3008 Cornwallis Road  
Research Triangle Park, North Carolina  
27709  
U.S.A.

**Apparatus:** Model 3440 Surface  
Moisture-Density Gauges

**Type of Equipment:** Measurement, Control, and  
Laboratory Use

**Class of Equipment:** Class A



## **Safety Warnings**

---

Owners are encouraged to require study of this manual before allowing anyone to use the gauge. **A potential hazard does exist if improperly used.** The sections of the manual covering radiological safety should be required reading for all users and potential users. **If these sections are not completely understood, users should seek assistance from Troxler, an appointed Troxler representative, or others designated within the user's organization.**

The following list of safety warnings applies to gauges with the CE mark and that are to be used in European countries. In addition to these safety warnings, all other safety warnings and cautions throughout this manual apply to gauges with the CE mark.

- ◆ There are no user-serviceable parts — only qualified service personnel should remove shields or covers to attempt repairs.
- ◆ Do not remove any shields or covers. A high-voltage hazard is located under the baseboard cover.
- ◆ The dc adapter shall be used on properly fused vehicle cigarette lighters only.
- ◆ European countries shall use a proper IEC input cord to the European charger (specified by local laws and practices).
- ◆ Do not throw batteries into fires. There is a risk of explosion.
- ◆ Use caution when lifting, moving, and/or carrying the gauge — it is heavy.

See Appendix D for radiation safety instructions

# NOTES

# Appendix H: Global Positioning System (GPS)

---

This appendix covers the following topics:

- ✓ GPS Accuracy

The Model 3440 Surface Moisture-Density Gauge can be equipped with an optional GPS (Global Positioning System) receiver that provides accurate information on the location (latitude and longitude) of the gauge.

## GPS Accuracy

---

As described earlier, the Model 3440 gauge can be equipped with an optional GPS receiver that determines the location (latitude and longitude) of the gauge. This information is stored with each gauge measurement. The GPS receiver used in the Model 3440 has *Wide Area Augmentation System (WAAS)* capabilities, which provides accuracy to within 3 m (10 ft.). However, the accuracy is dependent upon the user's location and other factors as described below.

The global positioning system is a satellite-based navigation system that consists of 24 satellites and a network of ground stations that monitor and control those satellites. The satellites orbit the earth at an altitude of approximately 11,000 miles and constantly transmit signal information back to earth. A GPS receiver uses this information to determine its location.

To determine its latitude and longitude, a GPS receiver must receive the signals from at least three satellites.

On average, the receiver used in the gauge is accurate to within 15 m (approximately 50 ft.) when receiving GPS data alone. However, the WAAS capabilities can increase the accuracy to within 3 m (10 ft.), as shown in Table 6.

The accuracy of GPS information can be affected by a number of atmospheric forces and other conditions. The Wide Area Augmentation System (WAAS) corrects for these factors by placing GPS receivers at 25 known, precisely surveyed locations, called *reference stations*, across the United States. The reference stations determined a *measured* distance to each satellite using the signals received from the satellites. For each satellite, the stations compare the *measured* distance to the *actual* range (as calculated from its known position) to determine a *differential correction* for each satellite

Two *master stations*, located on either coast, collect data from the reference stations to create a *GPS correction message*. This message is then broadcast through two geostationary satellites that are in a fixed position over the equator. The GPS receiver applies the correction factors contained in the correction message to increase the accuracy of its measurements.

Note that the signals from the WAAS satellites may not be available to gauge users in locations where trees, mountains, and other large objects obstruct the view of the horizon. On other occasions, the GPS receiver may not be able to access the signals from the three satellites required to determine a position. As noted earlier, the gauge stores location information with the results of each measurement. The measurement display also denotes the quality of the location fix as follows:

- ▶ If WAAS information is available during a gauge measurement, the latitude and longitude will be displayed to the nearest hundredth (1/100) of a second.
- ▶ If a GPS location is determined, but the WAAS information is unavailable, the latitude and longitude will be displayed to the nearest tenth (1/10) of a second.
- ▶ If the GPS receiver cannot determine a location, the latitude and longitude will be denoted as  $\theta$ .

### NOTE

The Wide Area Augmentation System (WAAS) is currently functional only in the United States.

### NOTE

If a Model 3440 equipped with the GPS option is moved a long distance between uses, the GPS system must be allowed to initialize. Initialization may take as long as 30 to 45 minutes after the gauge is powered and GPS enabled. The gauge must be positioned such that the GPS receiver can receive signals from the GPS satellites. If the GPS does not initialize within 45 minutes, contact your Troxler representative.

Table 6. GPS Position Accuracy

Quality of GPS Data	Accuracy	Fix Quality
GPS reading with WAAS	Within 3 m (10 ft.)	Latitude and longitude displayed to nearest 1/100 second
GPS reading without WAAS	Within 15 m (50 ft.)	Latitude and longitude displayed to nearest 1/10 second
No GPS reading	N/A	Latitude and longitude displayed as 0.



# INDEX

AC charger .....	1-5
Access code .....	xv
Accessories .....	1-5
Accident notification.....	C-3
Adapter, dc .....	1-5
Alkaline batteries.....	A-16
Alpha particles.....	D-4
Americium-241 beryllium .....	2-5
Americium-241:beryllium.....	4-16, D-8
Asphalt Mode setup.....	3-14
Asphalt mode .....	4-29
ASTM) standards .....	1-3
Atomic structure.....	D-2
Automatic Depth mode .....	3-9
Shutdown .....	3-7, B-4
Automatic shutdown .....	3-3
Auto-Store .....	8-12
Backscatter Geometry.....	2-3
Mode.....	2-2
Battery .....	A-11
Alkaline use.....	A-16
Charge .....	B-5, A-13
Charging .....	A-13
Low warning.....	9-6
Replace NiMH battery pack .....	A-14
Specifications .....	B-6, B-5
Status.....	5-18, A-11
Becquerel.....	D-3
Beeper, external.....	5-16

Beta particles.....	D-4
Bottom density.....	5-9
Cable pinouts.....	B-5
Calibration.....	2-7
Trench.....	7-9
Canadian Nuclear Safety Commission (CNSC).....	1-4, D-13, C-4
Canadian shipping requirements.....	C-4
Cesium-137 .....	2-2, 4-16, D-9, D-8
Charge	
Batteries.....	A-13
Charger, ac.....	1-5
Charging battery .....	A-13
Cleaning	
Base and top shell .....	A-17
Sliding block .....	D-10
Clock/Calendar.....	3-10, 9-3
Code of Federal Regulations (CFR).....	1-5
Contrast, display.....	A-10
Convert units.....	E-2
Count	
Standard.....	4-16
Time .....	3-8
Count time.....	5-3
Create project.....	8-5
Curie.....	D-3
Customer name .....	3-13, 9-3
Date	
Format.....	3-12
Date, changing.....	3-11
DC adapter.....	1-5
Deactivate project.....	8-11
Declaration of Conformity .....	1-4, G-2
Density .....	2-7, 4-29
Bottom.....	5-9
Measurement theory.....	2-2

Offset.....	2-7, 7-2
Offset enable.....	7-4
Department of Transportation (DOT).....	C-1
Depth	
Mode.....	5-3
Of measurement.....	2-5
Detectors.....	1-5
Direct transmission	
Geometry.....	2-3
Mode.....	2-2
Disable	
Moisture offset.....	7-8
Target value.....	6-4
Display	
Contrast.....	A-10
Specifications.....	B-5
Disposal.....	D-14
Drift test.....	5-6
Drill rod.....	1-5
Drill rod guide.....	1-5
Effect of top layer.....	2-2
Emergency procedures.....	D-14
Enable	
Density offset.....	7-4
Moisture offset.....	7-5
Target value.....	6-3
Encapsulation.....	D-8
Erase	
Project.....	8-6
Standard counts.....	9-5
Erratic readings.....	5-3
European considerations.....	G-1
Exposure, limiting.....	D-6
Extraction tool.....	1-5
Fix quality (GPS).....	H-3
Format	

Project output .....	8-8
Serial data .....	B-5
Gamma rays .....	D-4
Gasket, replacing .....	A-20, A-19
Gauge	
Measurement geometry .....	2-3
Source rod positions .....	3-5
Geiger-Mueller (G-M) detectors.....	2-2
Geometry, gauge measurement.....	2-3
Global positioning system (GPS).....	5-17, H-1
Initialization.....	5-17, H-3
Half-life.....	9-4
Half-value layer (HVL).....	D-7
Hazmat training .....	C-3
Humidity .....	F-6
ID number, sample .....	8-12
Index rod positions.....	3-5
Inspection	
Daily .....	3-6, D-9
Source rod .....	D-8
Upon receipt.....	1-7
International Air Transport Association (IATA) .....	C-1
International Atomic Energy Agency (IAEA) .....	C-1
K value (moisture offset) .....	7-5
Keypad.....	3-3, B-5
Leak test.....	D-12
Licensing.....	1-4, D-13
Liquid crystal display (LCD) .....	B-5
Log, standard count .....	F-1
Low battery warning .....	9-6
Lubricating source rod .....	A-19
Maintenance	
Gasket.....	A-19
Mechanical .....	A-17
Sliding block .....	D-10

Source rod bearing .....	A-18
Malfunction indicators .....	A-6
<b>Manual</b>	
Depth mode .....	3-9
Store .....	8-14
<b>Measurement</b>	
Asphalt mode.....	4-29
Mode.....	3-14
Site preparation .....	4-22
Soil mode.....	4-25
Source rod positions.....	3-5
Specifications .....	B-2
<b>Mechanical</b>	
Maintenance.....	A-17
<b>Menu</b>	
Target.....	6-2
<b>Mode</b>	
Asphalt.....	3-14
Backscatter.....	2-2
Depth.....	5-3
Direct transmission .....	2-2
Measurement.....	3-14
Nomograph .....	3-14
Ready.....	3-6
Soil.....	3-14
<b>Moisture</b>	
Measurement theory .....	2-5
New offset .....	7-5
Offset.....	2-7, 7-2
Offset disable .....	7-8
Offset enable.....	7-5
Offset, gauge-derived.....	7-7
Offset, manual entry.....	7-6
<b>Monitoring personnel.....</b>	D-7
<b>Neutrons.....</b>	D-4
<b>NiMH battery pack .....</b>	A-14
<b>Nomograph function.....</b>	5-9
<b>Offset .....</b>	2-7, 7-2

Density .....	2-7, 7-2
Menu .....	7-3
Moisture .....	2-7, 7-2
Trench .....	2-7, 7-2, 7-9
Options .....	5-16
O-ring, replacing .....	A-20
Output project .....	8-7
Destination .....	8-11
Parameter setup .....	3-8
Parts	
Gauge .....	1-5
Replacement .....	A-21
Percent air voids .....	5-18
Photons .....	D-4
Port	
Serial .....	8-7, 8-11
USB .....	8-7, 8-11, B-5
Position	
Safe .....	3-5
Source rod .....	3-5
Precautions .....	D-16
Precision .....	B-2
Function .....	5-14
Print	
Drift test .....	5-8
Stat test .....	5-5
Profile, radiation .....	D-17
Project	
Create .....	8-5
Deactivate .....	8-11
Erase .....	8-6
Menu .....	8-2
Output data .....	8-7
Output destination .....	8-11
Output format .....	8-8
Print data .....	8-7
Select .....	8-3

View .....	8-4
<b>Radiation</b>	
Converting units .....	E-2
Dose .....	D-5
Exposure .....	D-6
Monitoring .....	D-7
Profile .....	D-17
Safety .....	D-5
Specifications .....	B-4
Theory .....	D-2
Types .....	D-4
Radioactivity .....	D-3
<b>Reading</b>	
Asphalt mode .....	4-29
Soil mode .....	4-25
Ready mode .....	3-6
Recall data .....	4-31
Recharge time .....	B-5
Reference standard block .....	1-5, 4-16
Regulations .....	1-4, D-13
Canadian shipping .....	C-4
U.S. shipping .....	C-2
<b>Replace</b>	
Gasket and O-ring .....	A-20
NiMH battery pack .....	A-14
<b>Replacement</b>	
Gaskets .....	A-19
Parts .....	A-21
Safe position .....	3-5
Safety warnings (European countries) .....	G-3
Sample identification (ID) number .....	8-12
Scraper plate .....	1-5
Self-test .....	3-6
<b>Serial</b>	
Data format .....	B-5
Port .....	8-7, 8-11
Service .....	A-23

Service Centers.....	ii
Set units .....	5-3
Setup	
Depth.....	3-9
First-time.....	3-8
Measurement Units.....	3-9
Menu.....	5-2
Shielding.....	D-7
Shipper's Declaration for Dangerous Goods.....	C-2
Shipping.....	D-1
Canadian requirements .....	C-4
Case.....	F-6
U.S. requirements .....	C-2
Shutdown, automatic.....	3-3, 3-7, B-4
Site	
Asphalt measurement.....	4-24
Preparation.....	4-22
Soil and base course measurement .....	4-22
Standard count.....	4-16
Sliding block, cleaning .....	D-10
Software reset.....	9-7
Soil	
Mode setup.....	3-14
Source	
Americium-241:beryllium (Am-241:Be).....	9-4
Cesium-137 (Cs-137).....	9-4
Decay.....	9-4
Encapsulation .....	D-8
Rod inspection.....	D-8
Rod lubrication .....	A-19
Shielding .....	D-7
Source rod	
Bearing maintenance .....	A-18
Positions.....	3-5
Special European considerations .....	G-1
Specifications.....	B-1
Measurement .....	B-2



Standard count .....	4-16
Log .....	F-1
View .....	4-21
Stat test.....	5-3
Status	
Battery.....	5-18, A-11
Store	
Auto .....	8-12
Manual.....	8-14
Measurements.....	4-28, 4-31
Target value.....	6-4
Taking a measurement	
Asphalt mode.....	4-29
Soil mode.....	4-25
Target	
Menu .....	6-2
Target value	
Disable .....	6-4
Edit .....	6-3
Enable.....	6-3
Store .....	6-4
TDG.....	1-4
Temperature.....	F-6
Test	
Drift.....	5-6
Stat .....	5-3
Theory	
Density measurement.....	2-2
Moisture measurement.....	2-5
Offset.....	2-7
Radiation.....	D-2
Thermoluminescent dosimeter (TLD).....	D-7
Time	
Count.....	5-3
Format.....	3-12
Time, changing.....	3-11
Time, count.....	3-8

Top layer effect .....	2-2
Training .....	1-4, D-13
Hazmat.....	C-3
Transport case .....	1-5, F-6
Transport Packaging of Radioactive Materials Regulations (TPRM) .....	C-4
Transportation	
Canadian requirements .....	C-4
U.S. requirements .....	C-2
Transportation Guide.....	1-7
Transportation of Dangerous Goods Act and Regulations (TDG) .....	C-4
Trench offset.....	2-7, 7-2, 7-9
Troubleshooting .....	A-2
U.S. shipping requirements .....	C-2
Unit conversion.....	E-2
Units, measurement .....	5-3
Unpacking.....	1-7
USB port.....	8-7, 8-11, B-5
Compatible devices.....	8-11, B-5
User ID.....	3-13, 9-3
Vertical structure offset.....	7-9
View	
Drift test.....	5-8
Project .....	8-4
Standard counts .....	4-21
Stat test.....	5-5
Void ratio.....	5-18
Wide Area Augmentation System (WAAS).....	H-2

## **TROXLER ELECTRONIC LABORATORIES, INC.**

### **LIMITED WARRANTY**

TROXLER ELECTRONIC LABORATORIES, INC., and subsidiary, TROXLER

INTERNATIONAL, LTD., hereinafter referred to as "TROXLER," warrants this instrument, Model \_\_\_\_\_, Serial Number \_\_\_\_\_, against defects in material and workmanship for a period of twelve (12) months from date of shipment. For products sold through authorized TROXLER representatives, the date of shipment will be as of the transfer from representative to purchaser. During the applicable warranty period, TROXLER's obligation under this warranty shall be limited exclusively to the repair at a TROXLER facility at no charge, except for shipping to and from TROXLER'S plant, of any instrument which may prove defective under normal use and which TROXLER's examination shall disclose to its satisfaction to be thus defective. Normal use is defined for the purpose of this warranty as operation under normal load, usage, and conditions with proper care and maintenance and competent supervision. In no event shall TROXLER be held liable for damages, delays, or losses consequential, incidental, or otherwise attributable to the failure of this instrument. TROXLER's liability being specifically limited to repair as stated hereinabove. This warranty is automatically initiated except where modified by contractual or other written and signed agreement.

THERE ARE NO WARRANTIES WHICH EXTEND BEYOND THE DESCRIPTION ON THE FACE HEREOF, AND THIS WARRANTY IS EXPRESSLY IN LIEU OF ALL OTHER WARRANTIES, EXPRESSED OR IMPLIED, AND TROXLER NEITHER ASSUMES, NOR AUTHORIZES ANYONE TO ASSUME FOR IT ANY OTHER LIABILITY IN CONNECTION WITH THE SALE OF THE INSTRUMENT. THIS WARRANTY SHALL NOT APPLY TO THE INSTRUMENT OR ANY PART THEREOF, WHICH HAS BEEN SUBJECTED TO DAMAGE BY ACCIDENT, NEGLIGENCE, ALTERATION, ABUSE, MISUSE, OR SERVICE NOT AUTHORIZED IN WRITING BY TROXLER. SUCH DAMAGE TO INCLUDE BUT NOT BE LIMITED TO BURNING OF CIRCUIT BOARDS AND HARNESS FROM IMPROPER SOLDERING TECHNIQUES AND DAMAGE TO THE INSTRUMENT DUE TO PURCHASER'S FAILURE TO PERFORM MAINTENANCE AS OUTLINED IN THE AUTHORIZED OPERATOR'S MANUAL. DUE TO THE NATURE OF THEIR USE, MECHANICAL ACCESSORY PARTS AND BATTERIES ARE WARRANTED FOR 90 DAYS ONLY FROM DATE OF SHIPMENT.

**TROXLER ELECTRONIC LABORATORIES, INC.**

3008 E. Cornwallis Road  
Post Office Box 12057  
Research Triangle Park, NC 27709 USA

**NOTICE TO CONSUMERS**

Any disclaimer or limitation on the remedies expressed above shall not be effective to the extent prohibited by state or federal law.

NOTE: THIS WARRANTY EXCLUDES DAMAGE INCURRED IN SHIPMENT. IF THIS INSTRUMENT IS RECEIVED IN DAMAGED CONDITION, THE CARRIER SHOULD BE CONTACTED IMMEDIATELY. ALL CLAIMS FOR DAMAGE IN TRANSIT SHOULD BE FILED WITH THE CARRIER. IF REQUESTED, TROXLER WILL AID IN FILING OF CLAIMS AND/OR LOCATING PRODUCTS LOST IN TRANSIT.